

Guide

CONCRETE BASICS

A Guide to Concrete Practice

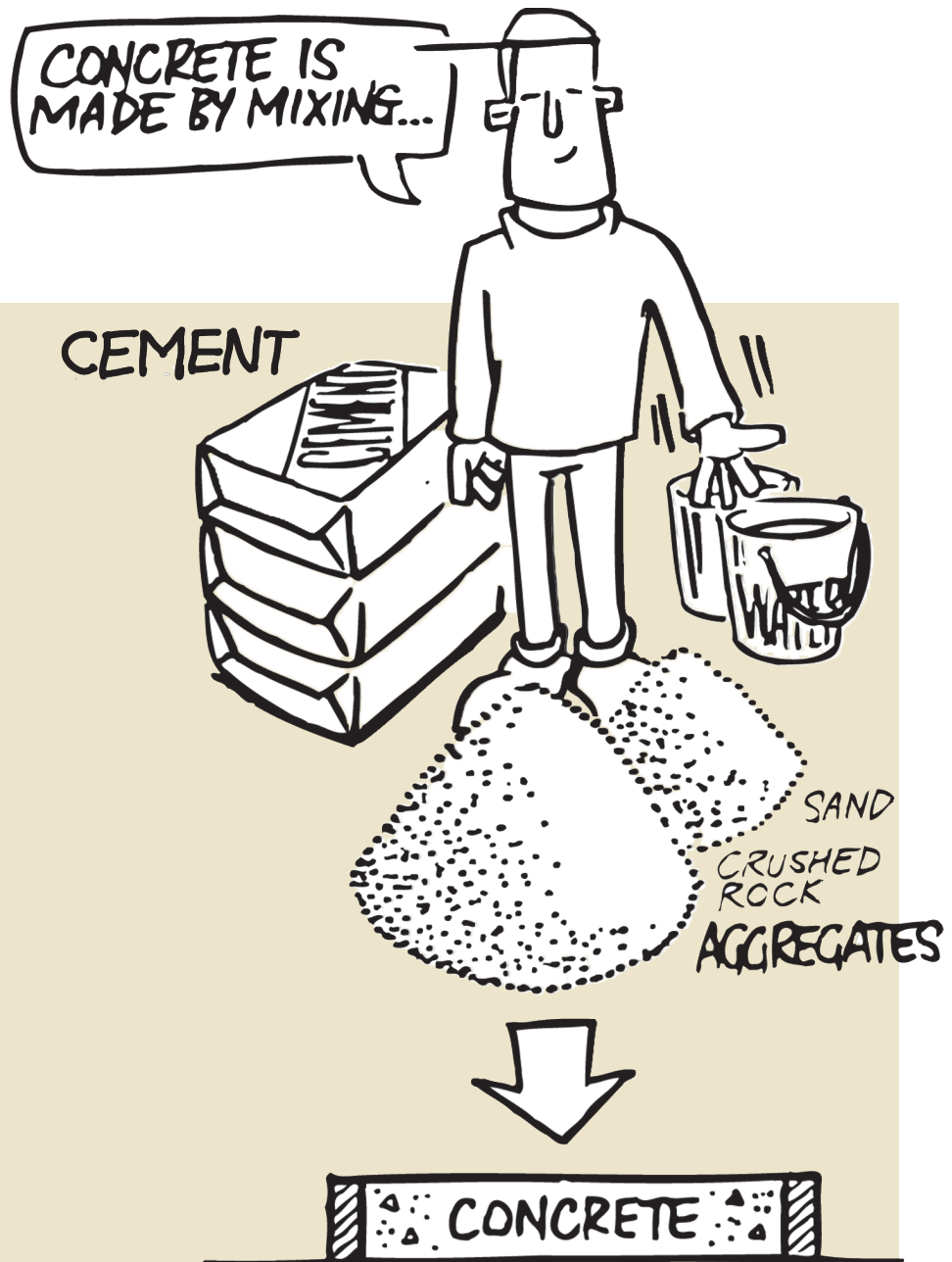



**CEMENT CONCRETE
& AGGREGATES AUSTRALIA**

Cement Concrete & Aggregates Australia

is a not-for-profit organisation established in 1928 and committed to serving the Australian construction community.

CCAA is acknowledged nationally and internationally as Australia's foremost cement and concrete information body – taking a leading role in education and training, research and development, technical information and advisory services, and being a significant contributor to the preparation of Codes and Standards affecting building and building materials.

CCAA's principal aims are to protect and extend the uses of cement, concrete and aggregates by advancing knowledge, skill and professionalism in Australian concrete construction and by promoting continual awareness of products, their energy-efficient properties and their uses, and of the contribution the industry makes towards a better environment.

Cement Concrete & Aggregates Australia
ABN 34 000 020 486

CCAA OFFICES

SYDNEY OFFICE:

Level 6, 504 Pacific Highway
St Leonards NSW Australia 2065

POSTAL ADDRESS:

Locked Bag 2010
St Leonards NSW 1590

TELEPHONE: (61 2) 9437 9711

FACSIMILE: (61 2) 9437 9470

BRISBANE OFFICE:

Suite 2, Level 2, 485 Ipswich Road
Annerley QLD 4103

TELEPHONE: (61 7) 3227 5200

FACSIMILE: (61 7) 3892 5655

MELBOURNE OFFICE:

2nd Floor, 1 Hobson Street
South Yarra VIC 3141

TELEPHONE: (61 3) 9825 0200

FACSIMILE: (61 3) 9825 0222

PERTH OFFICE:

45 Ventnor Avenue
West Perth WA 6005

TELEPHONE: (61 8) 9389 4452

FACSIMILE: (61 8) 9389 4451

ADELAIDE OFFICE:

PO Box 229

Fullarton SA 5063

TELEPHONE: (61 8) 8274 3758

PREMIXED CONCRETE AND
EXTRACTIVE INDUSTRIES OFFICE
PO Box 243

Henley Beach SA 5022

TELEPHONE: (61 8) 8243 2505

FACSIMILE: (61 8) 8125 5822

TASMANIAN OFFICE:

PO Box 246

Sheffield TAS 7306

TELEPHONE: (61 3) 6491 1509

FACSIMILE: (61 3) 6491 2529

WEBSITE: www.ccaa.com.au

EMAIL: info@cca.com.au

MORE Information

Cement Concrete & Aggregates Australia is committed to being the major source of information on cement, concrete and aggregates in Australia. For a complete listing of all retail and free publications please visit and bookmark CCAA website www.ccaa.com.au

CONCRETE BASICS A Guide to Concrete Practice

CONTENTS

Preface	page 2
CHAPTER 1 Concrete Materials	pages 3–5
CHAPTER 2 Concrete Properties	pages 6–9
CHAPTER 3 Concrete Testing	pages 10–13
CHAPTER 4 Ordering	page 14
CHAPTER 5 Proportioning and Mixing	pages 15–16
CHAPTER 6 Planning and Site Preparation	pages 17–19
CHAPTER 7 Transporting and Placing	pages 20–22
CHAPTER 8 Compacting	pages 23–25
CHAPTER 9 Finishing	pages 26–27
CHAPTER 10 Curing	pages 28–30
CHAPTER 11 Joints	pages 31–33
CHAPTER 12 Hot and Cold Weather Concreting	pages 34–35
CHAPTER 13 Colouring and Surface Finishes	pages 36–39
CHAPTER 14 Defects	pages 40–43
CHAPTER 15 Removing Stains	pages 44–46
CHAPTER 16 Cracking	pages 47–49
CHAPTER 17 Reinforced Concrete	pages 50–52
CHAPTER 18 Formwork	pages 53–54

First Published July 1991
Second Edition 1992
Third Edition 1994
Fourth Edition 1996
Fifth Edition October 2002
Sixth Edition August 2004
Seventh Edition February 2010

Cement Concrete & Aggregates Australia

Cement Concrete & Aggregates Australia is a not for profit organisation sponsored by the cement concrete and aggregate industries in Australia to provide information on the many uses of cement and concrete. This publication is produced by CCAA for that purpose. Since the information provided is intended for general guidance only and in no way replaces the services of professional consultants on particular projects, no legal liability can be accepted by CCAA for its use.

Preface

Communities around the world rely on concrete as a safe, strong and simple building material. It is used in all types of buildings (from residential to multi-storey office blocks) and in infrastructure projects (roads, bridges, etc).

Despite its widespread use, many people are unaware of the considerations involved in providing high quality, strong, durable concrete.

Concrete Basics provides a clear, concise explanation of all aspects of making quality concrete; from the Materials and Properties involved through Planning, Preparation, Finishing and Curing.

Concrete Basics addresses the needs of unskilled and semi-skilled persons undertaking general concreting projects including home and handyman projects. *Concrete Basics* also assists owner builders in the supervision of construction. It aims to develop an understanding of technical terms through clear definition accompanied by simple illustrations. A general understanding of these terms will help to facilitate communication within the building industry.

Concrete Basics will help to generate a higher standard of workmanship on site and facilitate better communication among construction workers, builders, engineers, building surveyors, architects and anyone interested in understanding the processes involved in making quality concrete.

CHAPTER 1 Concrete Materials

CONCRETE is made by mixing:

CEMENT
WATER
COARSE AND FINE AGGREGATES
ADMIXTURES (if required).

The aim is to mix these materials in measured amounts to make concrete that is easy to:

TRANSPORT
PLACE
COMPACT
FINISH

and which will set, and harden, to give a strong and durable product.

The relative amount of each material (ie cement, water and aggregates) affects the properties of concrete.

See CHAPTER 2 Concrete Properties

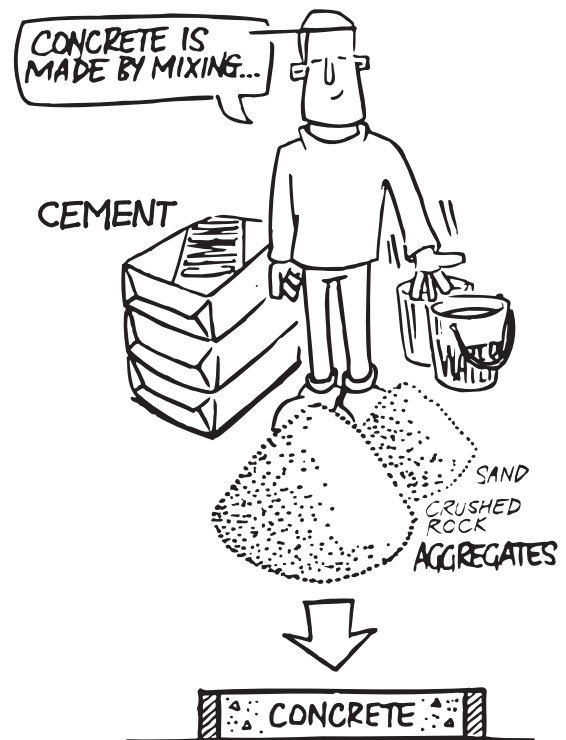

CEMENT The cement powder, when mixed with water, forms a paste.

This paste acts like glue and holds or bonds the aggregates together.

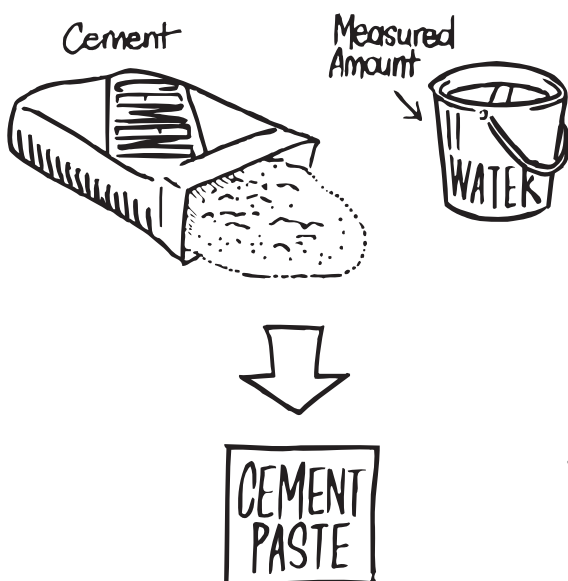

Six major types of cement are sold in Australia:

- Type GP (General Purpose Portland cement)
- Type GB (General Purpose Blended cement)
- Type HE (High Early Strength cement)
- Type LH (Low Heat cement)
- Type SR (Sulfate Resisting cement)
- Type SL (Shrinkage Limited cement)

Each type of cement will produce concrete with different properties.

The most commonly used are Type GP and Type GB.

Blended cements contain portland cement and more than 5% of either fly ash, ground slag, amorphous silica (eg silica fume), or a combination of these.

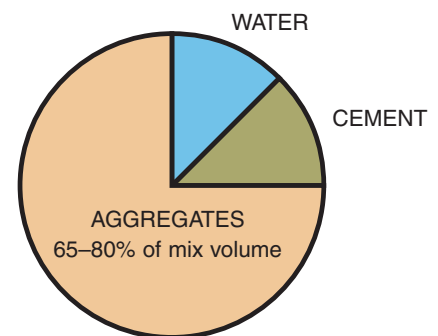

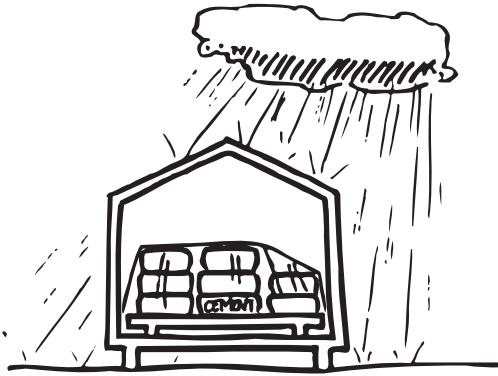

STORAGE Cement should be stored off the ground in a well-aired, clean, dry place.

Wrapping the cement bags in plastic sheets gives extra protection.

Bulk cement will normally be stored in silos.

AGGREGATES Aggregates are of two basic types:

COARSE: crushed rock, gravel or screenings.

FINE: fine and coarse sands and crusher fines.

Sand should be concreting sand and not brickies sand or plasterers sand.

Aggregates should be:

STRONG and HARD so as to give a strong final concrete – crumbly or flakey rock such as sandstone should not be used.

DURABLE to stand up to wear and tear and weathering.

CHEMICALLY INACTIVE so that the aggregates don't react with the cement.

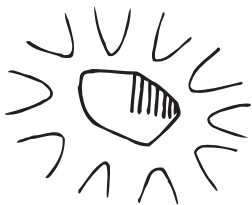

CLEAN since dirt or clay sticking to the aggregates will weaken the bond between paste and aggregates.

GRADED be of a range of sizes so that they fit together well to give a strong and dense concrete.

Rounded aggregates give a more workable mix.

Angular aggregates make concrete harder to place, work and compact, but can make concrete stronger.



STORAGE Aggregates should be stored where they will remain clean, separated from other materials and dry. If the aggregates are wet, less water should be used in the mix.

WATER Water is mixed with the cement powder to form a paste which holds the aggregates together like glue.



Water must be clean, fresh and free from any dirt, unwanted chemicals or rubbish that may affect concrete.

Many concrete plants now use recycled water.

Always check bore water before use.

Don't use sea water in reinforced concrete as it may rust the reinforcing steel.



ADMIXTURES Admixtures are mixed into the concrete to change or alter its properties, ie the time concrete takes to set and harden, or its workability.

HOW THE PROCESS WORKS

Measured amounts of the coarse and fine aggregates are mixed together.

A measured amount of cement is added and mixed in.

Enough water is added to make the mix workable. All the materials are then mixed together well. The cement powder and water form a paste which acts like a glue to bond the aggregates together.

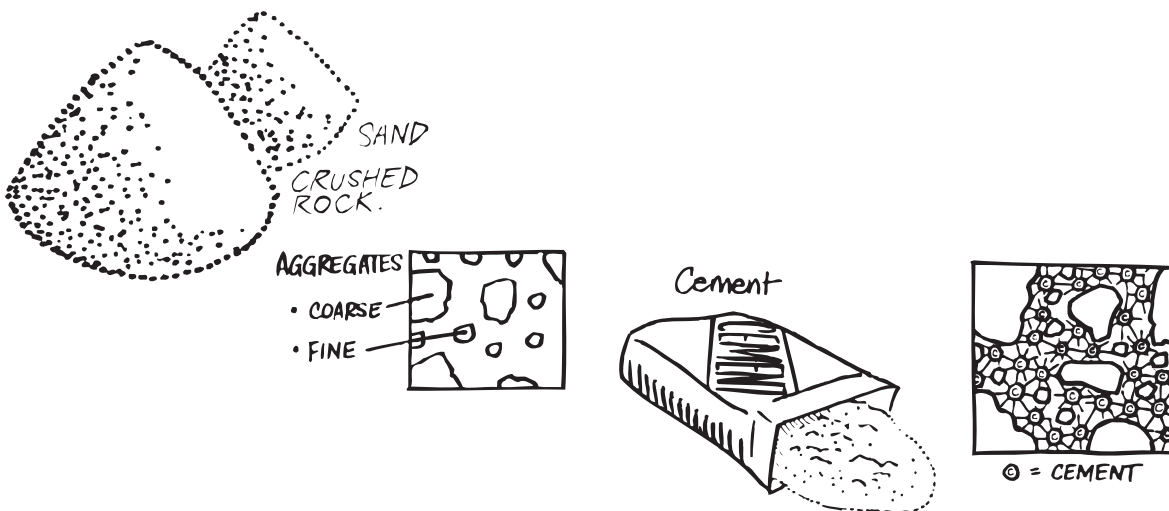

CHAPTER 2 Concrete Properties

The Properties of Concrete are its characteristics or basic qualities.

Concrete has three different states:

PLASTIC
SETTING
HARDENED

Concrete has different properties in each state.

The four main properties of concrete are:

WORKABILITY
COHESIVENESS
STRENGTH and
DURABILITY

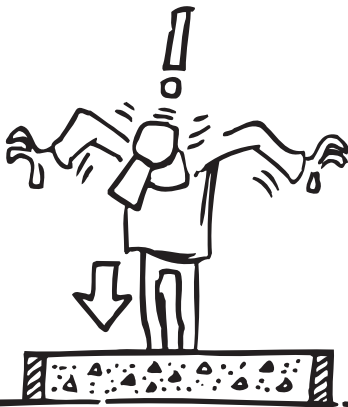

PLASTIC

PLASTIC STATE When the concrete is first mixed it is like 'bread dough'. It is soft and can be worked or moulded into different shapes. In this state concrete is called PLASTIC. Concrete is plastic during placing and compaction.

The most important properties of plastic concrete are workability and cohesiveness.

A worker will sink into plastic concrete.

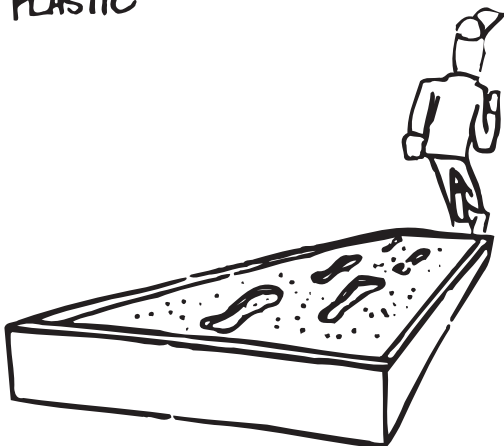

SETTING

SETTING STATE Concrete then begins to stiffen. The stiffening of concrete, when it is no longer soft, is called SETTING. Setting takes place after compaction and during finishing.

Concrete that is sloppy or wet may be easy to place but will be more difficult to finish.

A worker leaves footprints in setting concrete.

HARDENED STATE After concrete has set it begins to gain strength and harden. The properties of hardened concrete are strength and durability.

Hardened concrete will have no footprints on it if walked on.

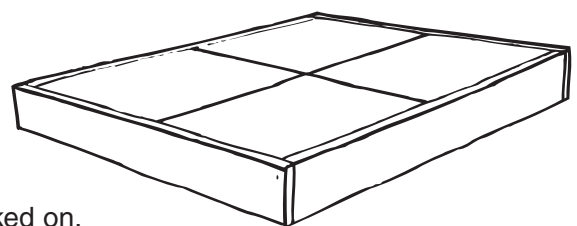

WORKABILITY Workability means how easy it is to:

PLACE
HANDLE
COMPACT and
FINISH the concrete.

Concrete that is stiff or dry may be difficult to handle, place, compact and finish and, if not constructed properly, will not be as strong or durable when finally hardened. A slump test can be used to measure the workability of concrete.

[See CHAPTER 3 Concrete Testing](#)

Workability is affected by:

THE AMOUNT OF CEMENT PASTE

The cement paste is the soft or liquid part of the concrete mix. The more paste mixed with the coarse and fine aggregates, the more workable a mix.

THE AGGREGATE PROPERTIES AND GRADING

Well-graded, smooth, rounded aggregates improve the workability of a mix.

[See Aggregate Grading under Cohesiveness.](#)

To make a more workable mix:

Add more CEMENT PASTE.

Use WELL GRADED aggregates.

Use an ADMIXTURE (admixtures that improve workability are known as plasticisers).

Never try to make a mixture more workable by just adding more water because this lowers the strength and durability of concrete.



COHESIVENESS Cohesiveness is how well concrete HOLDS TOGETHER when plastic.

Cohesiveness is affected by:

THE AGGREGATE GRADING

Graded aggregate means that there is a range of size of aggregates, from large rocks to small sands. Well-graded aggregates give a more cohesive mix, too much coarse aggregate gives a boney mix.

WATER CONTENT

A mix that has too much water will not be cohesive and may allow materials to separate (segregate).

STRENGTH AND DURABILITY Well made concrete is a naturally strong and durable material. It is DENSE, reasonably WATERTIGHT (impermeable), able to resist changes in TEMPERATURE, as well as wear-and-tear from WEATHERING and TRAFFIC.

Strength and Durability are affected by the density of the concrete. Denser concrete is stronger and more watertight (or less permeable).

Concrete durability INCREASES with strength.

Well made concrete is very important to protect the steel in reinforced concrete.

[See CHAPTER 17 Reinforced Concrete](#)

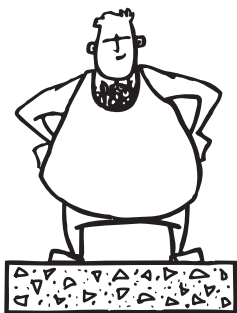

Strength of concrete in the hardened state is usually measured by the COMPRESSIVE STRENGTH using the Compression Test.

[See CHAPTER 3 Concrete Testing](#)

CONCRETE IS
VERY STRONG
IN
COMPRESSION

Strength and Durability are affected by:

COMPACTION Compaction is removing the air from concrete. Proper compaction results in concrete with an increased density which is stronger and more durable.

[See CHAPTER 8 Compacting Concrete](#)

CURING Curing is keeping concrete continuously damp for a period, to allow it to reach maximum strength. Longer curing will give more-durable concrete.

[See CHAPTER 10 Curing Concrete](#)

WEATHER Warmer weather will cause concrete to have a higher early strength.

See CHAPTER 12 Hot and Cold Weather Concreting

TYPE OF CEMENT Different types of cement will affect concrete properties, eg how quickly or slowly concrete gains strength.

THE WATER TO CEMENT RATIO Too much water and not enough cement means concrete will be weaker and less durable.

The water to cement ratio (W/C) is the weight of the water divided by the weight of cement.

$$\text{W/C} = \frac{\text{Water}}{\text{Cement}} \quad \text{eg} \quad \frac{20 \text{ litres}}{40 \text{ kg}} = 0.5 \quad \text{Note: 1 litre of water weighs 1 kilogram}$$

The lower the ratio, the stronger the concrete.

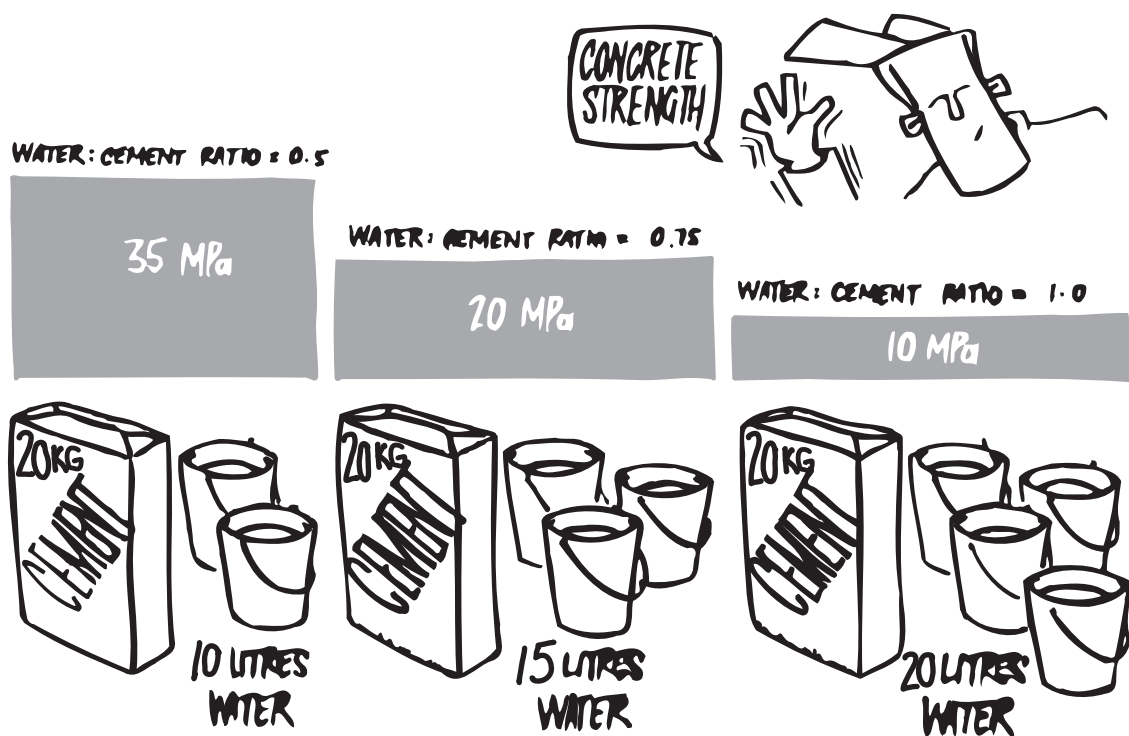

CONTENTS

10

CHAPTER 3 Concrete Testing

There are two main tests to be done on concrete:

The SLUMP test.

The SLUMP test indicates the WORKABILITY of concrete.

Workability shows how easy the concrete is to place, handle and compact.

See CHAPTER 2 Concrete Properties

The COMPRESSION test.

The COMPRESSION test shows the best possible strength concrete can reach in ideal conditions.

The compression test measures concrete strength in the hardened state.

Testing should always be done carefully. Wrong test results can be costly.

SAMPLING The first step is to take a test sample from the large batch of concrete. This should be done as soon as discharge of the concrete commences. The sample should be representative of the concrete supplied.

The SAMPLE is taken in one of two ways:

For purposes of accepting or rejecting the load: Sampling after 0.2 m³ of the load has been discharged.

For routine quality checks: Sampling from three places in the load as it is discharged.

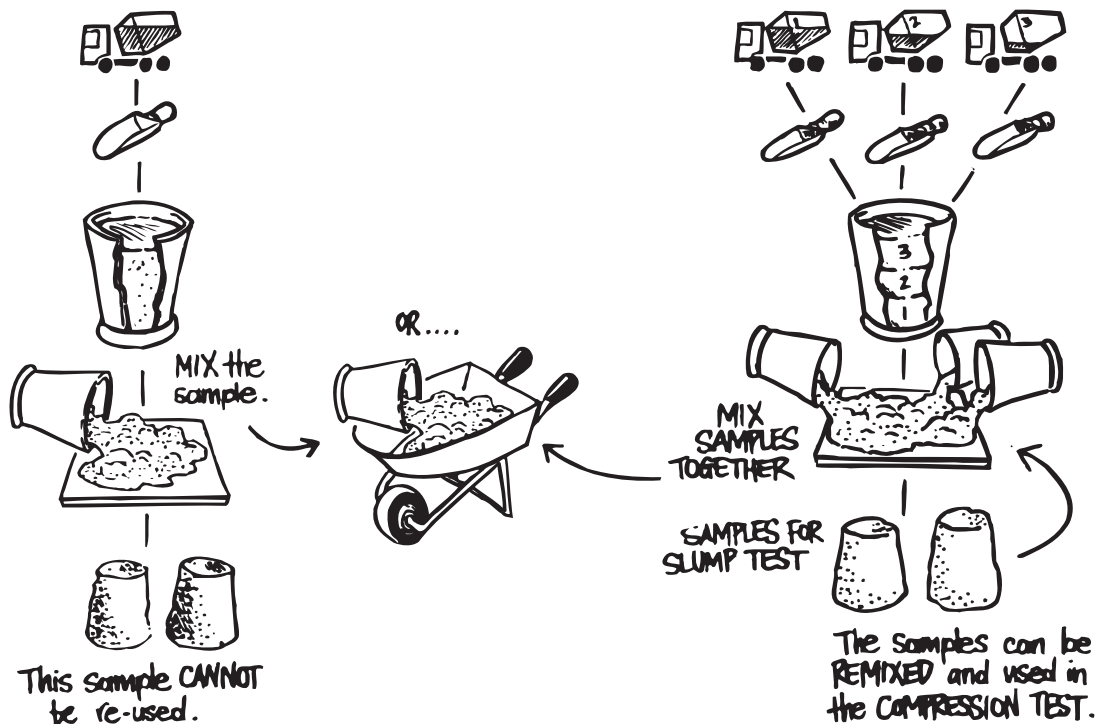

THE SLUMP TEST The slump test is done to make sure a concrete mix is consistent and workable. The measured slump must be within a set range, or tolerance, from the specified slump.

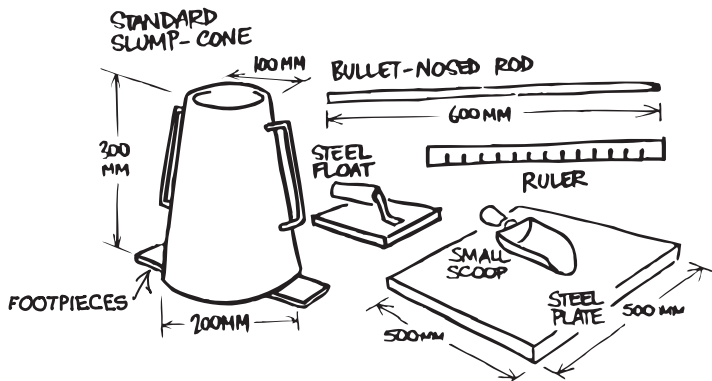

Tools

Standard slump cone
(100 mm top diameter x 200 mm bottom diameter x 300 mm high)

Small scoop

Bullet-nosed rod
(600 mm long x 16 mm diameter)

Ruler

Slump plate (500 mm x 500 mm)

Method

- 1 Clean the cone. Dampen with water and place on the slump plate. The slump plate should be clean, firm, level and non-absorbent.
- 2 Collect a sample. [See Sampling](#)
- 3 Stand firmly on the footpieces and fill 1/3 the volume of the cone with the sample. Compact the concrete by 'rodding' 25 times.

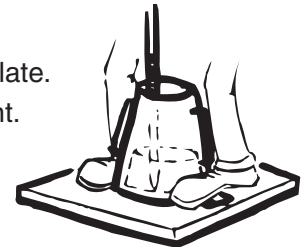

Rodding Rodding means to push a steel rod in and out of the concrete to compact it into the slump cone. Always rod in a definite pattern, working from outside into the middle.

- 4 Now fill to 2/3 and again rod 25 times, just into the top of the first layer.
- 5 Fill to overflowing, rodding again this time just into the top of the second layer. Top up the cone until it overflows.
- 6 Level off the surface with the steel rod using a rolling action. Clean any concrete from around the base and top of the cone, push down on the handles and step off the footpieces.
- 7 Carefully lift the cone straight up making sure not to move the sample.

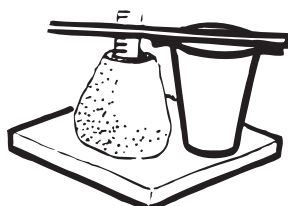
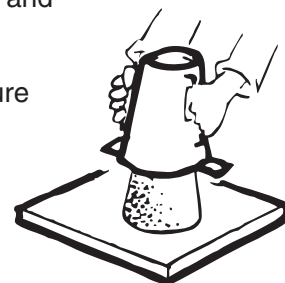
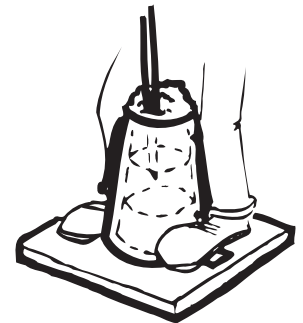
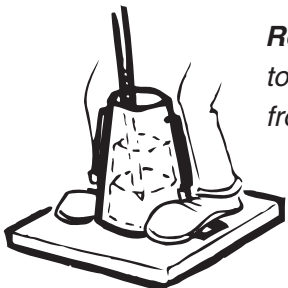

- 9 Take several measurements and report the average distance to the top of the sample.
- 10 If the sample fails by being outside the tolerance (ie the slump is too high or too low), another must be taken. If this also fails the remainder of the batch should be rejected.

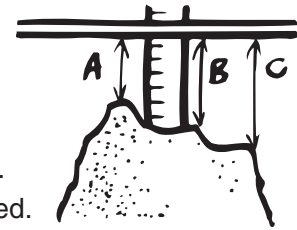

THE COMPRESSION TEST The compression test shows the compressive strength of hardened concrete. The testing is done in a laboratory off-site. The only work done on site is to make a concrete cylinder for the test.

The strength is measured in Megapascals (MPa) and is commonly specified as a characteristic strength of concrete measured at 28 days after mixing. The compressive strength is a measure of the concrete’s ability to resist loads which tend to crush it.

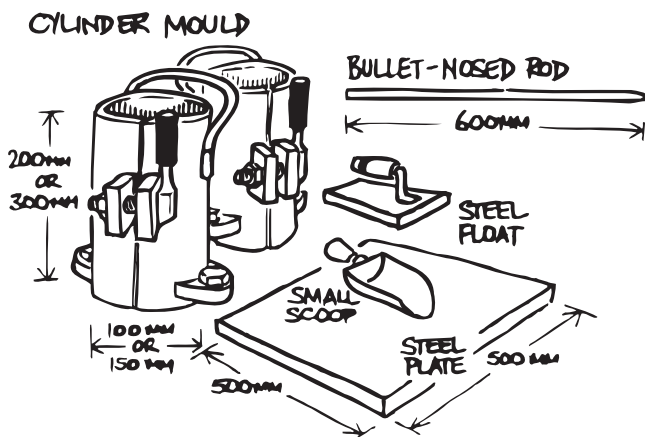

Tools

- Cylinders (100 mm diameter x 200 mm high or 150 mm diameter x 300 mm high – the small cylinders are normally used for most testing due to their lighter weight)
- Small scoop
- Bullet-nosed rod (600 mm long x 16 mm diameter)
- Steel float
- Steel plate

Method

- 1 Clean the cylinder mould and coat the inside lightly with form oil, then place on a clean, level and firm surface, eg the steel plate.
- 2 Collect a sample. [See Sampling](#)
- 3 Fill 1/2 the volume of the mould with concrete then compact by rodding 25 times. Cylinders may also be compacted by vibrating using a vibrating table.

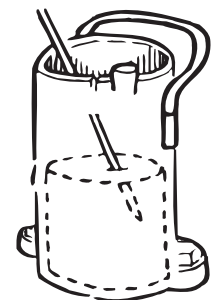

CONTENTS

13

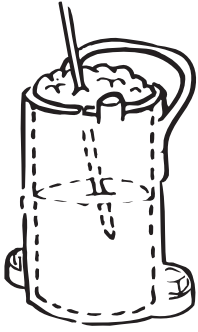

4 Fill the cone to overflowing and rod 25 times into the top of the first layer, then top up the mould until overflowing.

5 Level off the top with the steel float and clean any concrete from around the mould.

6 Cap, clearly tag the cylinder and put it in a cool dry place to set for at least 24 hours.

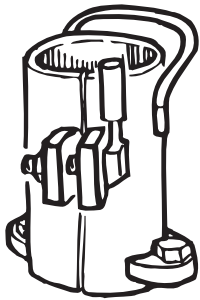
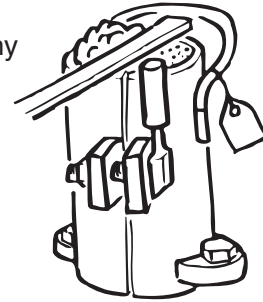
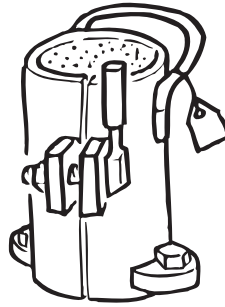

7 After the mould is removed the cylinder is sent to the laboratory where it is cured and crushed to test compressive strength.

CHAPTER 4 Ordering

WHEN ORDERING PRE-MIXED concrete you will need to tell the supplier:

Name and **address** for delivery

The **use** of the concrete (ie driveway, housing slab, commercial)

The **amount** you need in cubic metres

The **Class** of the concrete. There are two classes that concrete can be supplied as: Normal Class and Special Class.

NORMAL CLASS CONCRETE has a strength grade of N20, N25, N32, N40 and N50 with the corresponding characteristic strength of 20, 25, 32, 40 and 50 MPa at 28 days. The slump at the point of delivery should be 20–120 mm and the maximum size of coarse aggregate should be 10, 14 or 20 mm. Normal class concrete is suitable for most purposes. For most domestic applications such as driveways and paths grade N20 and N25 are the common grades ordered.

SPECIAL CLASS CONCRETE is specified when you have additional or alternative requirements to those for normal class concrete, eg lightweight aggregate, colour pigments, a non-standard strength grade. Special class concrete will not always be available from every concrete supplier.

The **slump** in millimetres (mm).

[See slump test in CHAPTER 3 Concrete Testing](#)

The **maximum aggregate size** (eg 20 mm).

How you want to **place** the concrete (eg pump, chute, wheelbarrow, etc).

Time of the first truckload and the time between truckloads. There must be enough time to place and compact one load before the next arrives.

Any **admixtures** you may want in the concrete, though this is normally left to the pre-mixed concrete supplier.

Always **order more** concrete (ie 10%) than you need to allow for construction variations and/or some wastage. Concrete is ordered in 0.2-m³ increments.

Ensure you round up when ordering.

IF MIXING YOUR OWN concrete:

The cement powder is ordered in bags by weight (eg 20 kg) and type (eg Type GP).

The coarse and fine aggregates are ordered in cubic metres by maximum size (eg 20 m³ of size 20 mm).

Water is used by the litre or kilogram (1 litre of water = 1 kilogram).

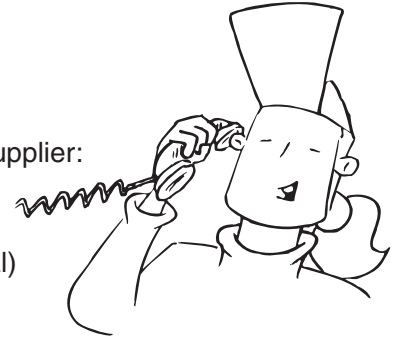

CHAPTER 5 Proportioning and Mixing

A CONCRETE MIX is designed to produce concrete that can be easily placed at the lowest cost.

The concrete must be workable and cohesive when plastic, then set and harden to give strong and durable concrete.

The mix design must consider the environment that the concrete will be in; ie exposure to sea water, trucks, cars, forklifts, foot traffic or extremes of hot and cold.

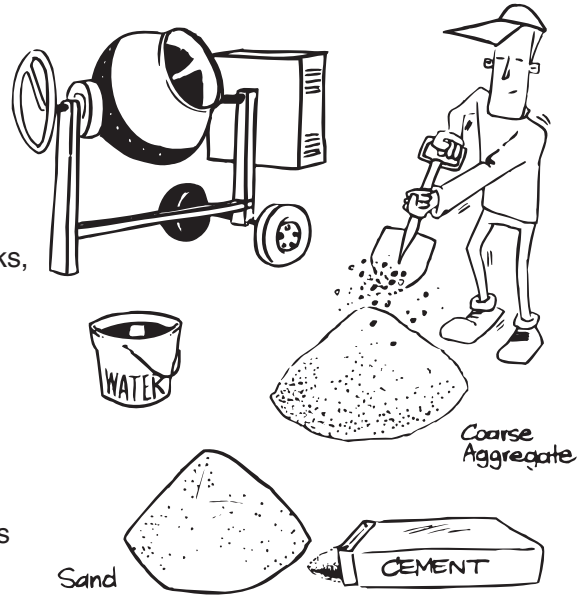

PROPORTIONING Concrete is a mixture of cement, water, coarse and fine aggregates and (possibly) admixtures.

The proportions of each material in the mixture affects the properties of the plastic and hardened concrete. These proportions are best measured by weight. Measurement by volume is not as accurate, but is satisfactory for minor projects.

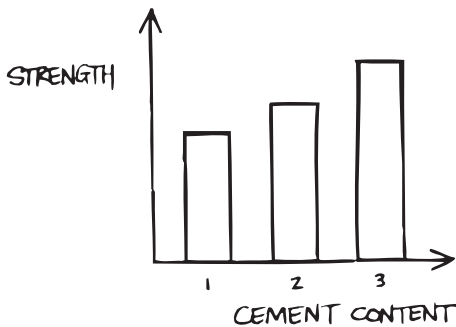

CEMENT CONTENT As the cement content increases, so does strength and durability. Therefore, to increase the strength, increase the cement content of a mix.

WATER CONTENT Adding MORE WATER to a mix gives a WEAKER hardened concrete. Always use as little water as possible, only enough to make the mix workable.

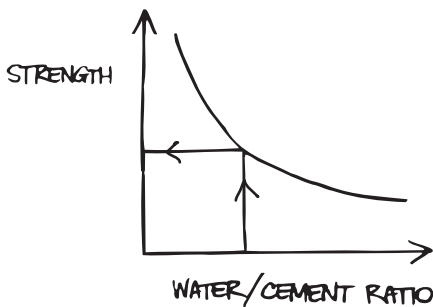
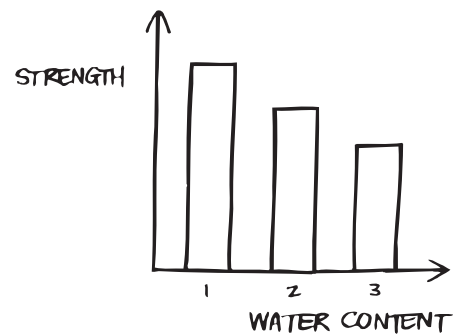

WATER TO CEMENT RATIO As the Water to Cement ratio INCREASES, the strength and durability of hardened concrete DECREASES. To increase the strength and durability of concrete, decrease the Water/Cement ratio.

[See CHAPTER 2 Concrete Properties](#)

After compaction,
no stone in top few millimetres

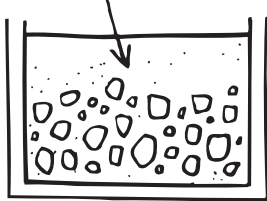

AGGREGATES

Too much fine aggregate gives a sticky mix.

Too much coarse aggregate gives a harsh or boney mix.

After compaction,
stones protrude

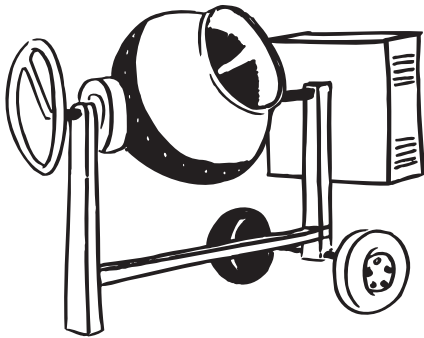
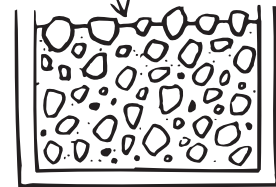

MIXING Concrete must be mixed so the Cement, Water, Aggregates and Admixtures blend into an even mix.

Concrete is normally mixed by MACHINE. Machine mixing can be done on site or by a premixed concrete supplier. Premixed concrete is batched (proportioned) at the plant to the job requirements.

Truck Mixing The materials are normally added to the trucks at batching plants and mixed for the required time and speed at the plant. The truck's drum continues to rotate to agitate the concrete during transportation to the site.

Site Mixing When site mixing, begin by loading a MEASURED AMOUNT of coarse aggregate into the mixer drum. Add the sand before the cement, both in measured amounts.

NEVER USE A SHOVEL AS A MEASURE AS VOLUMES CAN VARY WIDELY.

Mix materials together until there is no visible sand in the mix.

Add enough water to get a workable mix.

Be careful not to overload the mixer. Too much concrete in the mixer means each batch takes longer to be properly mixed, which causes costly delays in the long run or it will not mix at all.

Always check how much the mixer holds so you know how much concrete can be produced at one time.

Avoid delays between batches to get maximum output.

Small quantities of concrete may be mixed by hand with a shovel. Mixing should be done on a clean board, or plate, or in a wheelbarrow. Mix the materials together until they are even. Then dish the material and add water. Use only enough water to get an even, workable mix. Finish mixing.

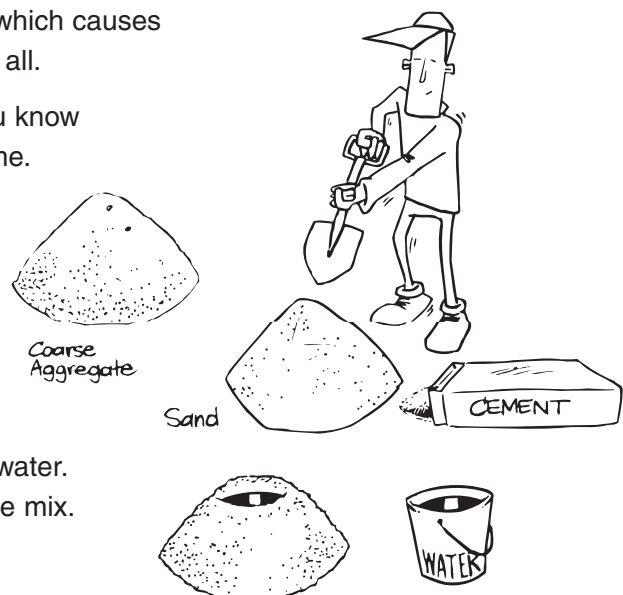

CHAPTER 6 Planning and Site Preparation



The most important step in placing concrete is planning. Always plan every step before any concrete is delivered.

Proper planning avoids delays, wastage, segregation and problems which develop from these.

To eliminate problems of delay, segregation and wastage,

[See CHAPTER 7 Transporting and Placing](#)

SAFETY Workers on the site should always wear protective clothing, strong boots, helmets and eye protection. Always avoid direct contact with cement and never kneel in or touch the plastic concrete directly. Wear gloves and use barrier creams.

Ensure that anyone using heavy equipment, such as screeds or vibrators, has been properly trained.

The following steps should be taken before any concrete is placed.

MEASUREMENT Measure and stake out the area to be concreted and consider how thick the slab must be.

The thickness will depend on the weight the concrete must carry (ie a driveway carries the weight of a car and needs to be thicker than a garden path).

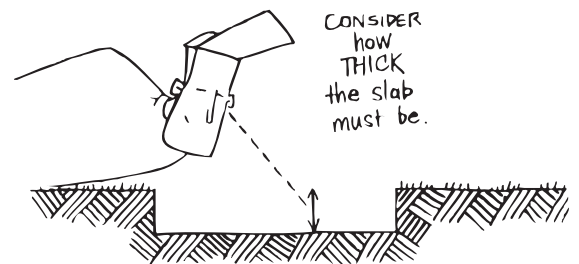

THE FINISHED LEVEL Once the thickness of concrete has been established, work out where the concrete will finish. Concrete cannot finish too high against steps or the external house wall and should not cover any part of weepholes in the wall. The finished level determines how much digging or excavation must be done. Pavements must slope away from buildings and boundaries.

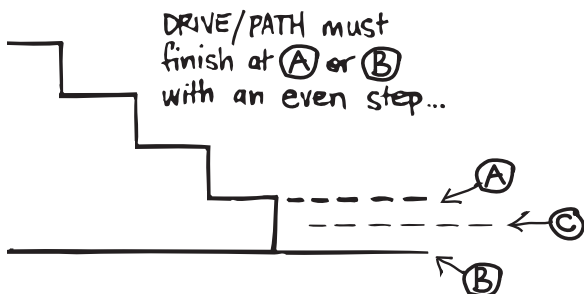

it shouldn't finish at (C).

STEPS Steps must have equal risers.

EXCAVATION The ground should be excavated as required by the finished levels. Any roots or grass must be dug out until there is firm soil to place on. Always dig the hole wider than needed to allow for the formwork. Try to keep the edges and corners square.

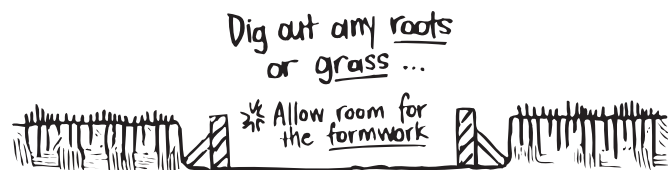

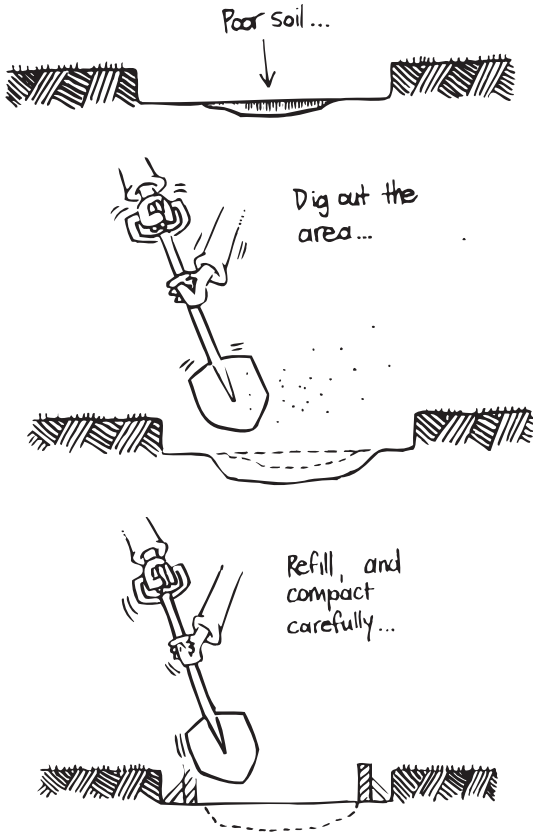

SUBGRADE The soil a concrete pavement or floor rests on is called the subgrade. If the soil is soft or varies in softness, a layer of crushed rock (known as a subbase) should be provided. If there are only a few poor areas these can be dug out, refilled and compacted. It is important that the soil evenly supports the concrete.

Many later problems can be avoided by properly preparing the subgrade.

FORMWORK

Formwork gives concrete its shape, Formwork should be properly braced so it is strong. It should not flex or move.



See CHAPTER 18 Formwork

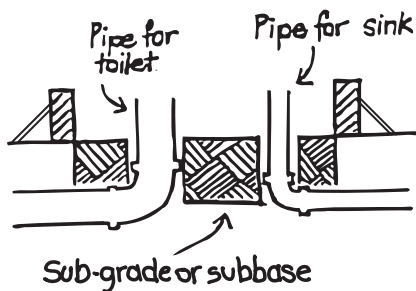

ANY SERVICES RUNNING THROUGH THE CONCRETE SHOULD BE IN PLACE.

SERVICES Plumbing, heating or electrical services often run through a slab. These must be in place before any concrete is placed.

UNDERLAY AND SERVICES The underlay, or vapour barrier, is a heavy plastic covering the ground to minimise water vapour rising through the hardened concrete. Always overlap the sheets a minimum of 200 mm and do not tape them. Tape the edges of sheets only around drainage pipes or services which pass vertically through the concrete slab.

Termite protection may be required around service penetrations, at joints and around the perimeter of the slab.

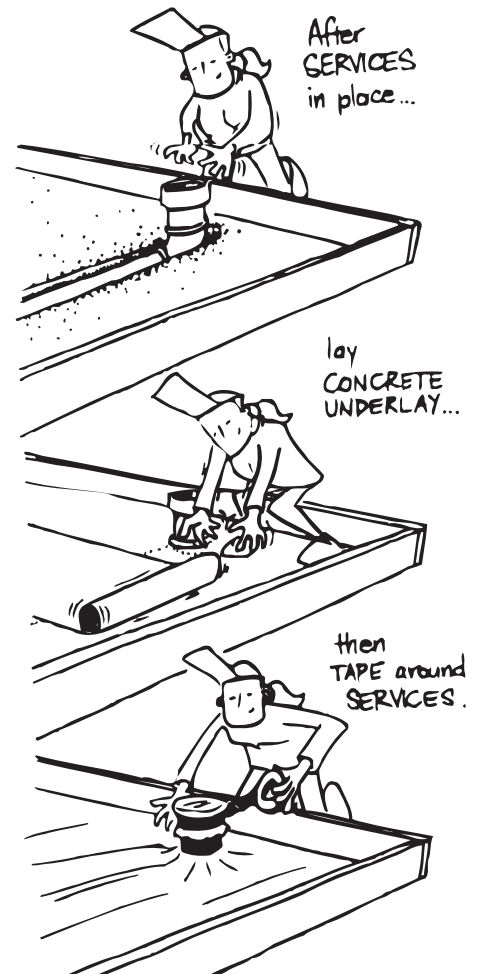

REINFORCEMENT Reinforcement can be used to increase the strength of concrete and/or to help control cracking.

For house floors resting on the ground it is placed in the top 1/3 of slabs and in the bottom of thickening and beams. In strip footings, it is placed in the top and bottom.

The reinforcement must be covered by a specified amount of concrete which protects the steel from rusting. This is called cover. The amount of cover depends on whether the slab is inside or outside, is in contact with the ground or protected by a membrane. It is measured to the top, side or bottom of the outer surface.

Reinforcement should be securely held for slab on ground construction. Bars and mesh should overlap by a specified amount and at the corners of strip footings.

See CHAPTER 17 Reinforced Concrete

ACCESS Clear access must be provided to transport the concrete.

If concrete is to be delivered by trucks make sure they have unrestricted access to the site in all weather conditions.

PLACEMENT Ensure all planning and site preparation takes into account how concrete will be placed – allowing room for trucks, ramps for wheelbarrows, space for a pump, etc.

JOINTS The position, type and number of joints should be planned well before the concrete is placed.

See CHAPTER 11 Joints

WASTAGE Good planning and site preparation reduces wastage. Reducing wastage can cut costs, since up to 15% of concrete can be lost this way.



WASTAGE can be avoided.

CHAPTER 7 Transporting and Placing

When transporting and placing concrete, avoid:

DELAYS
SEGREGATION and
WASTAGE.

TRANSPORTATION The method used to transport concrete depends on which one is the most cost effective and easiest for the job size and site.

Transport methods include: a concrete truck, a concrete pump, a crane and bucket, a chute, a conveyor or a hoist. For small jobs on which concrete cannot be placed directly from the truck chute, a wheelbarrow is the easiest way to transport it.

Always transport concrete as little as possible on site to reduce problems of segregation and wastage.

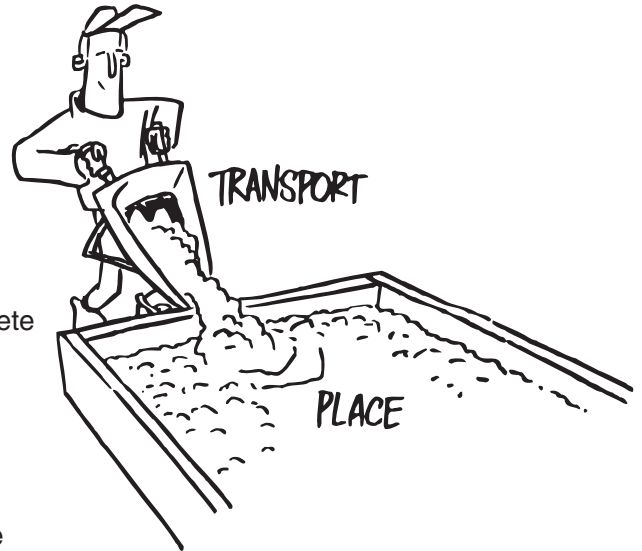

PLACING When placing concrete be careful not to damage or move the formwork and reinforcement.

Place concrete as near to its final position as possible.

Start placing from the corners of the formwork or, in the case of a sloping site, from the lowest level.



IMPORTANT SAFETY INFORMATION

When handling and using cement or fresh concrete, avoid skin contact. Wear suitable protective clothing.

DELAYS Delays can cause the concrete to dry-out and stiffen.

Delays are more of a problem on hot and/or windy days when the concrete will dry-out and stiffen more quickly.

To avoid delays plan ahead. Check that all labour, tools and containers are ready and that all preparations for placing have been done before the concrete is delivered.

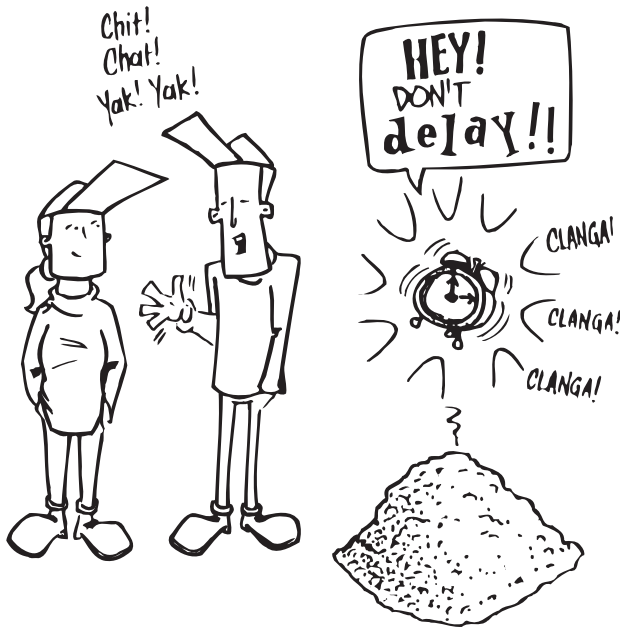

NEVER just add water to the concrete to make it more workable.



SEGREGATION Segregation is when the coarse and fine aggregate, and cement paste, become separated. Segregation may occur when the concrete is mixed, transported, placed or compacted.

Segregation makes the concrete:

WEAKER,
LESS DURABLE,
and will leave A POOR SURFACE FINISH.

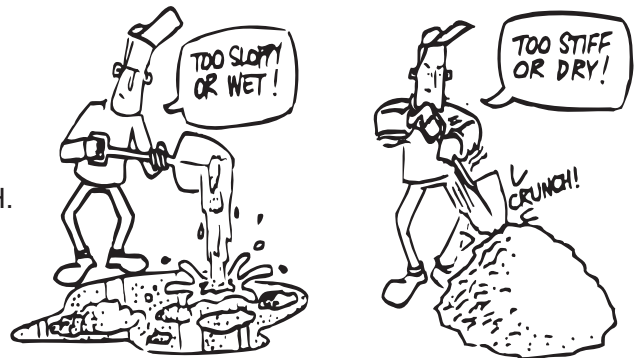

To avoid segregation:

Check the concrete is not 'too wet' or 'too dry'.

Make sure the concrete is properly mixed. It is important that the concrete is mixed at the correct speed in a transit mixer for at least two minutes immediately prior to discharge. The concrete should be placed as soon as possible. When transporting the mix, load carefully.

If placing concrete straight from a truck, place vertically and never let the concrete fall more than one-and-a-half metres.

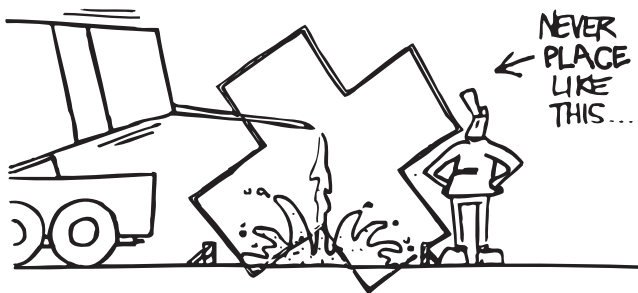

Always place new concrete into the face of concrete already in place.

When compacting with a poker vibrator be sure to use it carefully.

See CHAPTER 8 Compacting

Never spread concrete sideways with a poker vibrator as this may cause segregation of the mix.

Always be sure to vibrate concrete evenly.



WASTAGE Wastage can be costly, especially on small jobs. To minimise wastage; mix, load, transport and place carefully.

CHAPTER 8 Compacting

WHAT IS COMPACTION? Compaction is the shaking or vibrating of the concrete to liquify it and expel any trapped air.

The concrete settles, filling all the space in the forms.

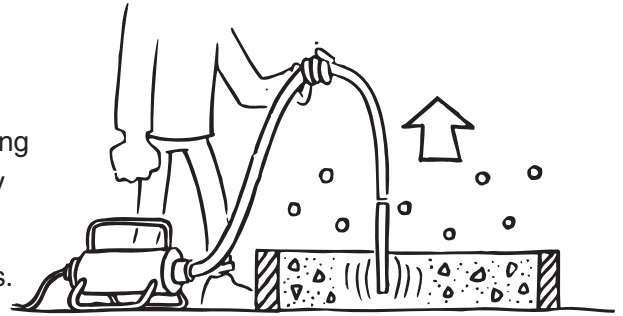

- As you shake & vibrate the concrete the AIR is pushed out.



WHEN TO COMPACT Compaction must be done as concrete is placed, while it is still plastic. Never let concrete dry out and stiffen because it will be too difficult to compact.

WHY COMPACT Properly compacted concrete is more dense, strong and durable. Off-form finishes will also be better.

EXTERNAL VIBRATION

Screeding Screeding levels and compacts thin concrete slabs and the top layers of thicker slabs. A screed board will not compact the concrete very well. Mechanical vibration or hand rodding is required to provide adequate compaction.

The Mechanical Screed A double-beam mechanical screed compacts the concrete TWICE.

The first beam levels the concrete roughly and compacts it.

The second beam levels and compacts the concrete further.

The screed is pulled along the top of the forms by two workers.

Always keep a small amount, or surcharge, of concrete, in front of both beams of the screed to avoid hollows forming in the surface. If a hollow develops, the screed will not compact the concrete.

The mechanical screed compacts the concrete as it vibrates.

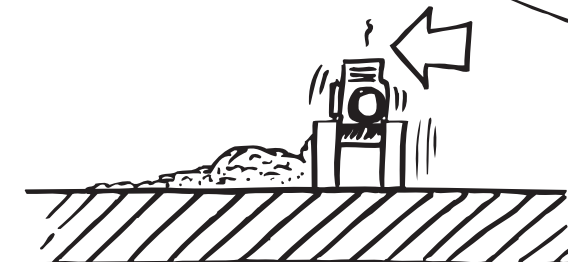
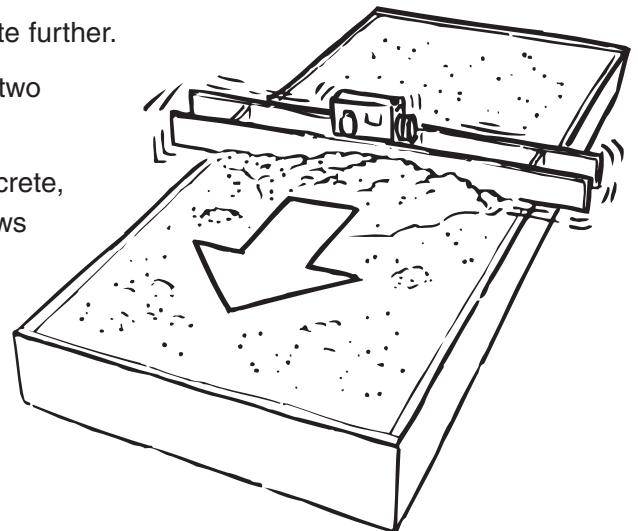

INTERNAL VIBRATION Internal vibration is done with a mechanical vibrator or poker vibrator. The POKER is put into concrete and vibrates it from the inside.

Method

Put the poker into the concrete QUICKLY. Take the poker out very SLOWLY otherwise a hole, or weak spot, may be left in the concrete.

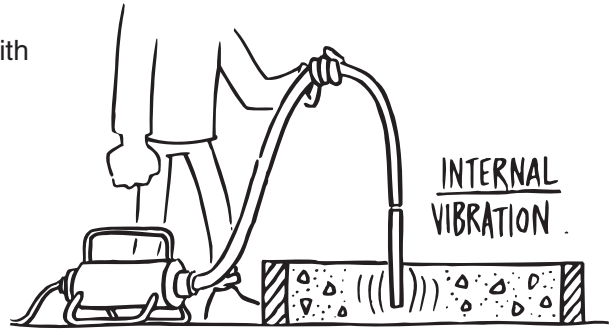

Make sure there are enough workers so some can compact while others continue to place.

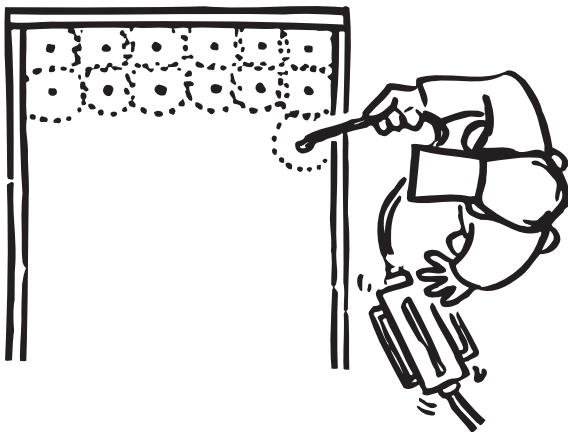
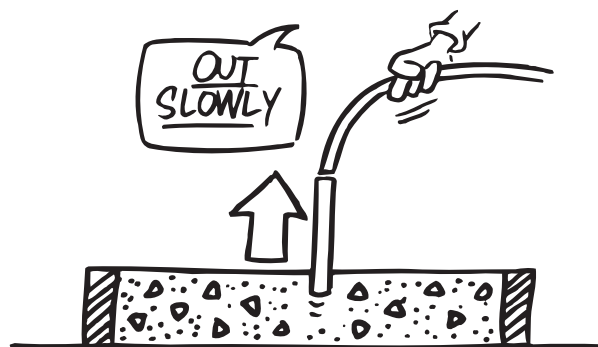
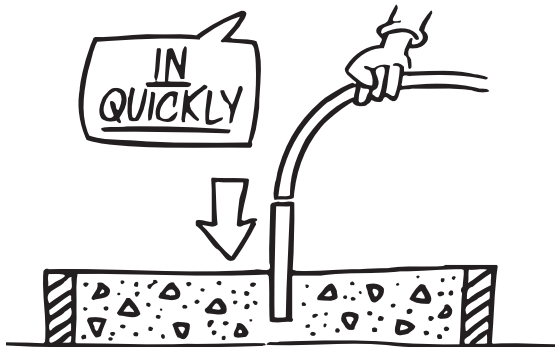

The SIZE of the poker determines how much concrete is vibrated at one time.

The area vibrated at one time is called the RADIUS OF ACTION. This can be seen by the radius over which air bubbles rise to the surface.

The radius of action will be greater with a LARGER poker and more-workable concrete.

Always compact in a definite pattern so the radius of action overlaps and covers the whole area of the concrete.

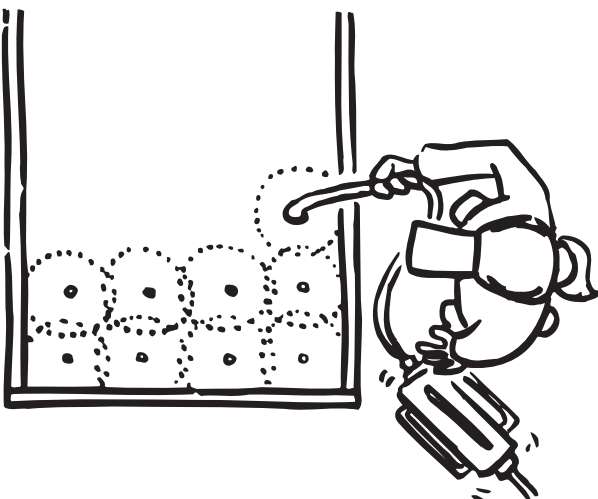

Where concrete is placed in layers, the poker should be long enough to reach and enter into the layers of concrete under the one being compacted.

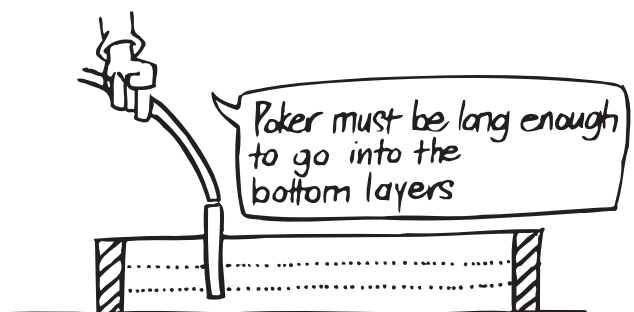

PRECAUTIONS Taking the poker out TOO QUICKLY will leave a hole in the concrete. To close the hole, vibrate near the hole and take the poker out VERY SLOWLY.

NEVER touch the form face with the poker as it can damage the formwork and the concrete and can affect the off-form finish.

NEVER touch the reinforcement with the poker as it may reduce the bond to the concrete.

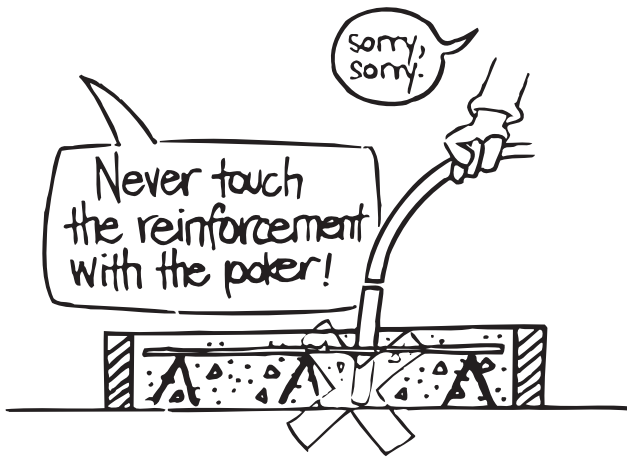
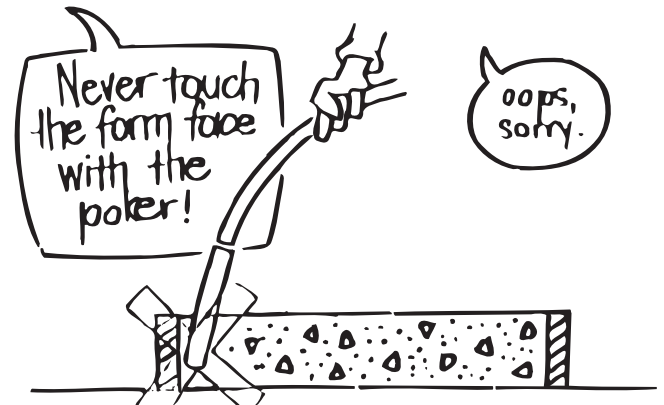

NEVER spread or move concrete sideways with the poker as it may cause segregation, always use a shovel.

NEVER leave the poker running when not in use.

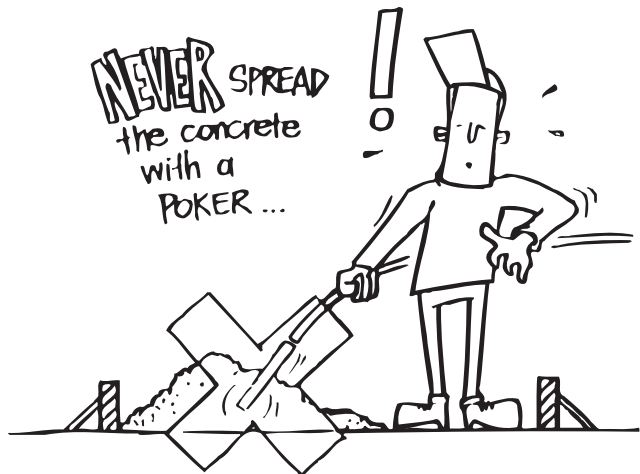

HOW LONG TO COMPACT For concrete of average workability (ie slump of 80 mm) with a poker size between 25–75 mm, concrete should usually be vibrated for between 5 and 15 seconds.

It is worse to UNDER-VIBRATE than to OVER-VIBRATE concrete.

CHAPTER 9 Finishing

WHAT IS FINISHING? Finishing is screeding, floating and/or trowelling the concrete surface to densify and further compact the surface layer of concrete, as well as giving it the look you want.

Finishing takes place in two stages:

INITIAL and
FINAL finishing.

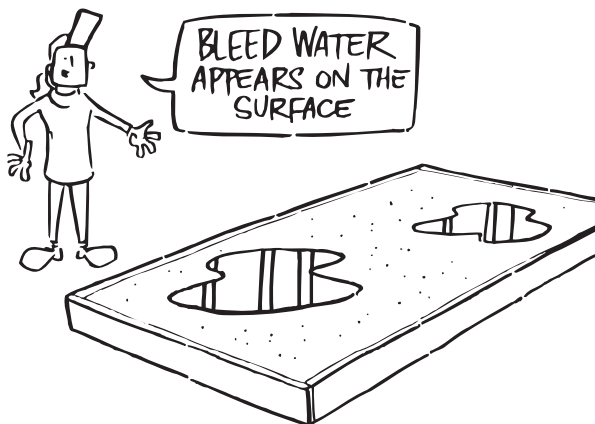
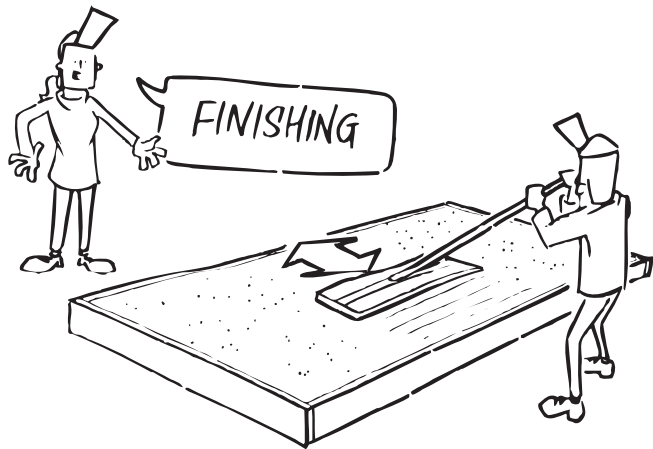

No final finishing can begin while bleed water is present. Mixing bleed water with the surface paste will weaken it, possibly resulting in a dusty surface.

INITIAL FINISHING Concrete is first screeded to the level of the formwork, then bullfloated and left to set.

In some cases screeding leaves a good enough finish, especially if floor coverings are to be used over the concrete.

Water then appears on the surface of the concrete. This water is called bleed water.

Excess bleed water can be removed by dragging an ordinary garden hose across the surface of the concrete.

Never try to dry up the bleed water using stone dust or cement as this will weaken the concrete surface in the long run.

Once the bleed water dries up and concrete can support a person's weight, with only a slight marking to the surface, the final finishing can begin.

FLOATING There may be two stages in floating:

The BULLFLOAT, which is part of the initial finishing.

The POWER or HAND FLOAT which is part of the final finishing.

Floating helps compact and level the surface and close minor cracks.

See CHAPTER 16 Cracking

Floating can be done by hand or with a power float. Power floating leaves a better finish than hand floating.

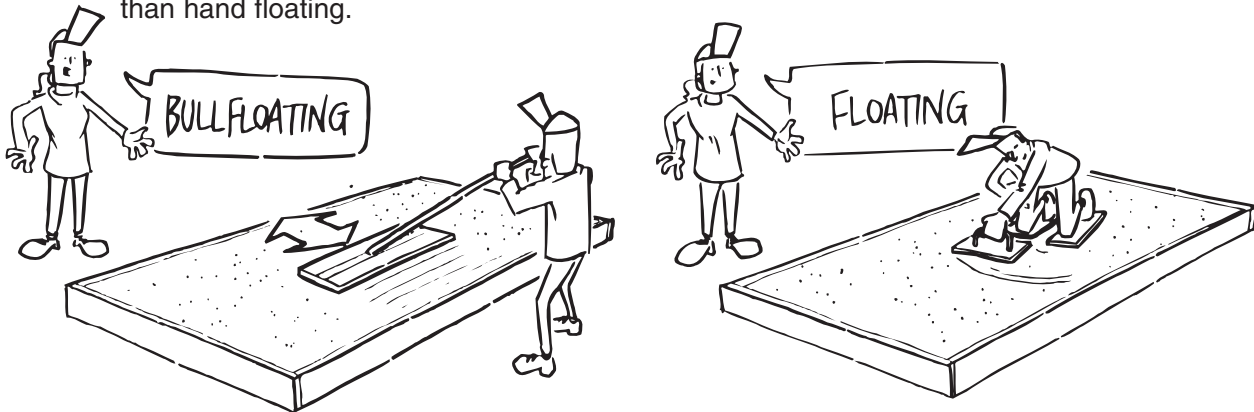

FINAL FINISHING This involves floating, trowelling, edging, jointing or patterning the concrete. Special finishes such as brooming, colouring or patterned finishes can be applied to the surface.

See CHAPTER 13 Colouring and Surface Finishes

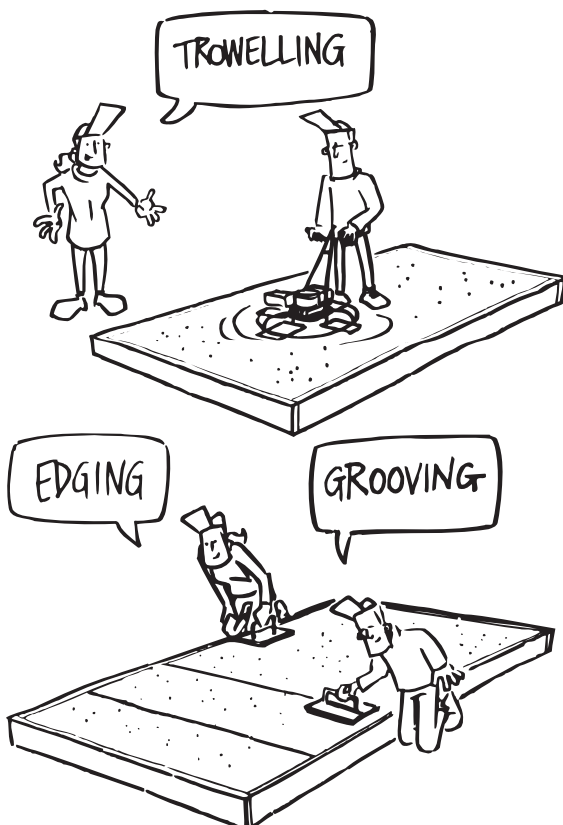

Trowelling Trowelling leaves a dense, hard, smooth and durable surface.

The surface should be trowelled TWICE. A well trowelled surface will be very smooth and can be slippery when wet. Trowelling can be done by hand or power trowel.

Edging and Grooving All the edges of a slab should be finished with a special edging tool. This gives a neater and stronger edge, less prone to chipping. Joints should be planned before placing and are usually formed into the concrete during finishing.

See CHAPTER 11 Joints

Once any surface has been finished the concrete *MUST* be cured.

See CHAPTER 10 Curing

CHAPTER 10 Curing

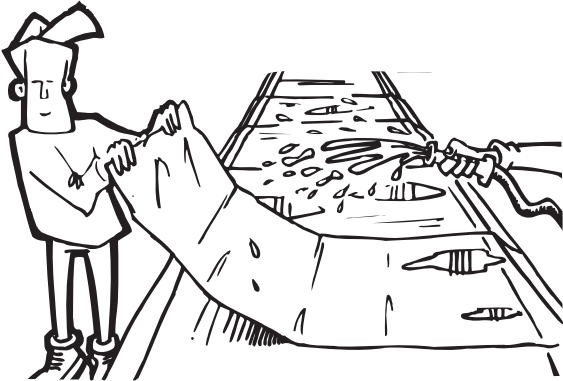

WHAT IS CURING? Curing means to keep concrete **MOIST** for some time (typically 3–7 days).

By keeping concrete moist the bond between the paste and the aggregates gets stronger. Concrete doesn't harden properly if it is left to dry out quickly.

WHEN TO CURE Curing is commenced just after finishing the concrete surface.

Precautions When curing leave the formwork in place to help reduce moisture loss. In hot weather (above 30°C), or during high winds and low humidity, concrete can dry out quickly. In these conditions take extra care with curing.

See CHAPTER 12 Hot and Cold Weather Concreting

WHY CURE Concrete that is cured is:

LESS LIKELY TO CRACK.
STRONGER.
MORE DURABLE.

Cured concrete has a surface that wears better, lasts longer and better protects the steel reinforcement.

Properly cured concrete is stronger and can carry more weight without breaking.



HEAVY LOADS
DON'T WORRY ME.



HOW TO CURE The most common ways of curing are:

APPLYING EXTRA WATER to the surface of the concrete, or
REDUCING the rate of moisture loss from the concrete.

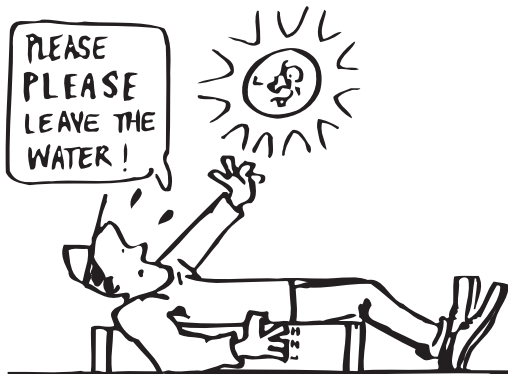

Applying extra water

The simplest method of APPLYING WATER is to put a continuous fine, misty spray of water over the concrete.

BEWARE: The spray must be a very fine mist or else it will damage the surface of the concrete.

Concrete will dry out more quickly in hot weather. Keep the concrete continuously moist.

It is most important to keep the concrete moist at all times. Hosing in the morning and again at night and letting the concrete dry out in between is no good.

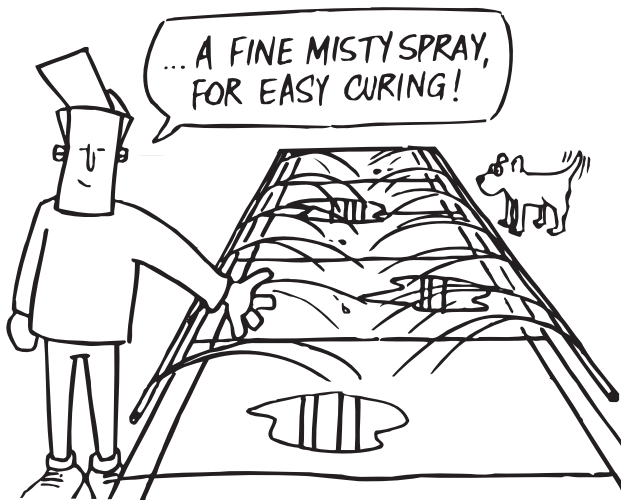

Reducing moisture loss

Another way to cure concrete is to cover with PLASTIC SHEETS to slow down moisture loss.

This method is easy and inexpensive. The only problem is that the sheets may cause concrete to become darker in places. To avoid this keep concrete EVENLY moist.

The sheets must be held down to stop them blowing away. They can be overlapped and stuck together and/or held down with sand, timber or bricks.

Always check under the plastic from time to time to make sure the concrete is EVENLY moist. If it feels dry, sprinkle with water and put back the plastic sheets carefully. Condensation on the underside of the plastic is a good sign.



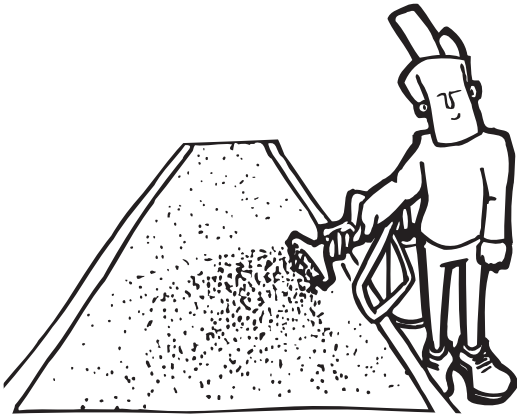

Concrete may also be cured by applying a CURING COMPOUND which slows moisture loss. This should be applied soon after finishing. Always follow the manufacturer's instructions carefully. Curing compounds may be sprayed, rolled or brushed on.

BEWARE: Some types of curing compounds may later make it harder or impossible to apply a surface finish such as paint to concrete, or to stick down floor coverings. When using a curing compound, check with the supplier to ensure compatibility with surface coatings or adhesives for future overlay finishes such as vinyl or tiles.

In rapid drying conditions (ie high wind, dry air and/or hot air) the use of an EVAPORATION RETARDER minimises the rapid loss of surface moisture and as such reduces the incidence of early age plastic cracking.

See CHAPTER 16 Cracking

These products contain a fugitive dye and are applied after initial screeding and floating, and reapplied after each successive surface working until finished. In severe conditions retarders will require reapplication. Evaporation retarders are not curing compounds; their effect is temporary therefore once the concrete is finished, normal curing techniques should still be used immediately.

HOW LONG TO CURE Concrete keeps getting HARDER AND STRONGER over TIME.

Household concrete jobs MUST be cured for at least 3 DAYS.

For better strength and durability, cure concrete for 7 DAYS.

The LONGER concrete is cured, the closer it will be to its best possible strength and durability.

See CHAPTER 2 Concrete Properties and See CHAPTER 3 Concrete Testing

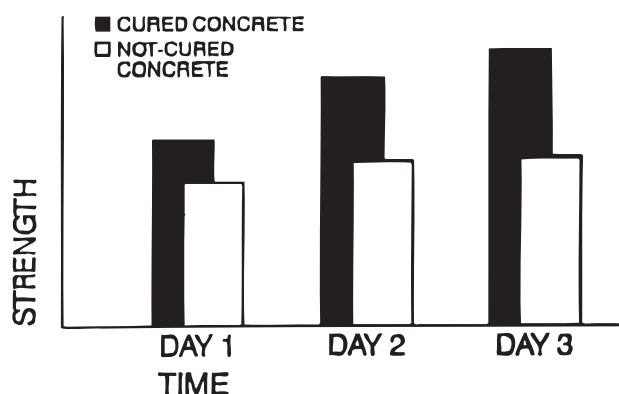

CHAPTER 11 Joints

WHAT ARE JOINTS? Joints are PLANNED BREAKS in concrete which allow it to move and thus prevent random cracking.

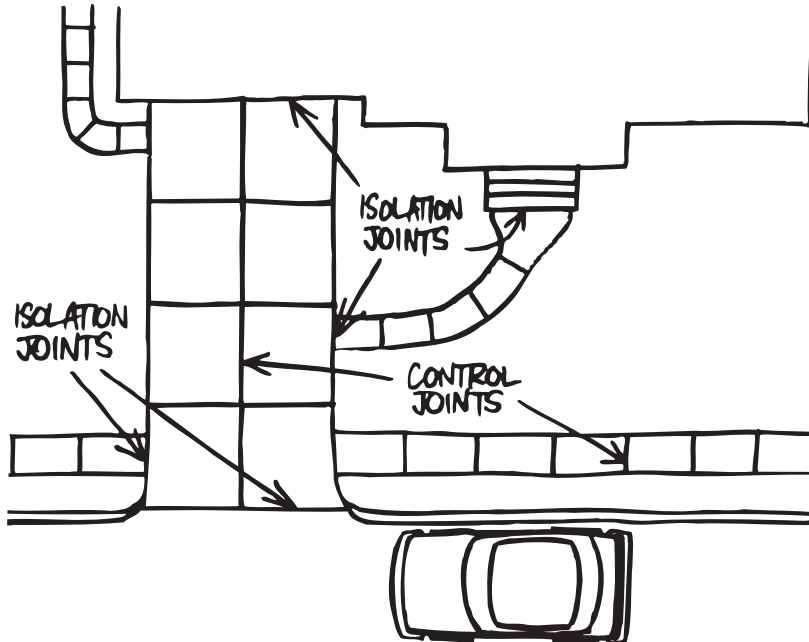

WHEN TO MAKE JOINTS Joints can be made at two different times:

BEFORE any concrete is placed (for Construction joints or Isolation joints).

AFTER concrete has been placed and compacted (for Control joints).

Joints are used to control CRACKING in concrete. Random cracking can weaken the concrete and spoil its appearance.

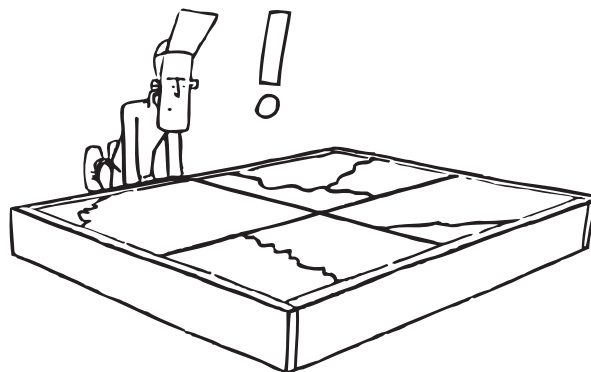

TYPES OF JOINTS

Control Joints Wet-formed (tooled) joints are provided by the use of a grooving tool to create a plane of weakness to control where shrinkage cracks will occur and to conceal them. To be effective the joint must be tooled to a minimum depth of $\frac{1}{4}$ to $\frac{1}{3}$ the depth of the concrete, eg for 100 mm thick concrete – joint depth should be a minimum of 25 mm to 35 mm.



Control joints may be made while concrete is hardening by slicing it with a thin piece of metal. The edges of the joints should be finished with a grooving or edging tool.

See CHAPTER 9 Finishing

Alternatively, a crack inducer may be cast, or pressed into, the concrete.

Control joints may also be sawn, but timing is very important. Too early and the cut will not be clean; too late and the concrete will have already cracked randomly.

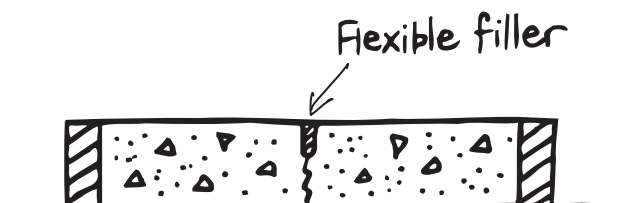
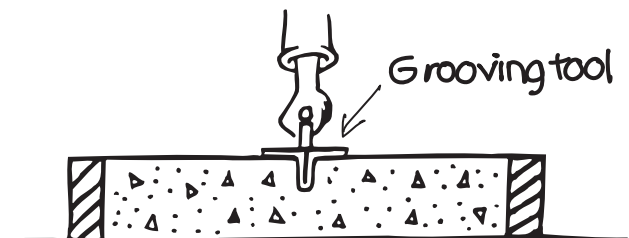

A tooled or sawn joint may be sealed with a flexible material to minimise water entry and to prevent stones, etc entering which may later cause spalling of the concrete edges.

The position and number of control joints must be carefully planned. Control joints in an unreinforced concrete slab should divide it into roughly square areas. If rectangular, the ratio of the sides should not exceed 1 : 1.5.

Control joints in unreinforced concrete should be spaced at about 20 to 25 times the thickness of the slab, eg in a 100-mm slab the joint spacing should be 3 m maximum. In steel-reinforced slabs the joint spacing is controlled by the area of steel. The more steel there is, the further apart the joints can be.

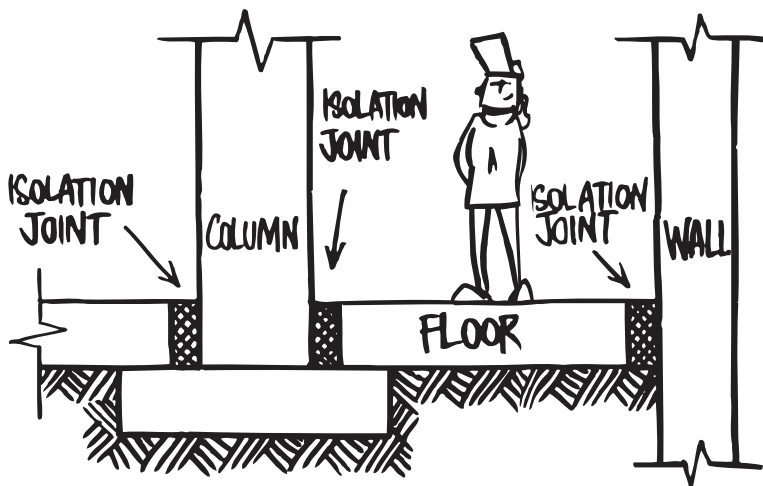

Isolation Joints An isolation joint totally separates a concrete element from another concrete element, or a fixed object such as a wall or column, so that each can move and not affect the other. The joint filling should be full depth and soft. It can be made of cork, foam rubber, or some other flexible material.

Construction Joints A construction joint is a place where work finishes temporarily. Formwork is used to support the edge of the concrete already in place so that it doesn't just collapse. Concrete is finished square and the reinforcement normally runs through the joint.

When placing begins again:

Remove the formwork and brush any loose material from the old surface.

Roughen the old surface, to expose the coarse aggregate, to help the new concrete bond properly.

Place the new concrete against the old surface.

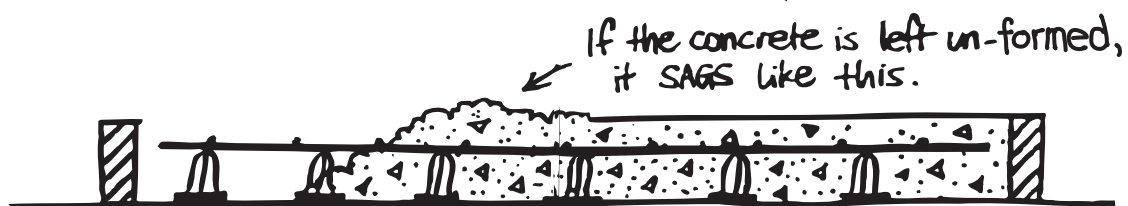
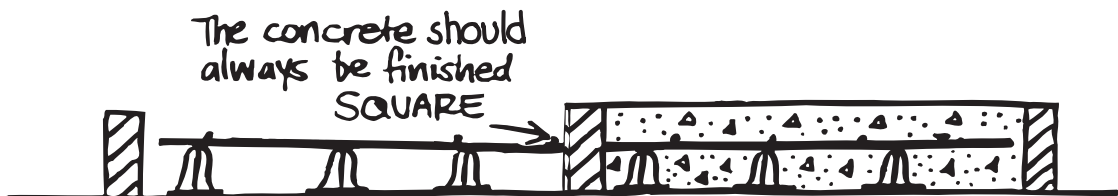

PLANS The position of ALL JOINTS should be shown on the plans for any concrete slab.

CHAPTER 12 Hot and Cold Weather Concreting

In extremes of heat and cold concrete must be:

HANDLED
PLACED
COMPACTED
FINISHED and
CURED carefully.



The main problem caused by extremes of heat and cold is cracking. When conditions of heat and cold are expected some of the following precautions will improve the quality of your final concrete.

IN HOT WEATHER

Workability In hot and/or windy weather a concrete mix may stiffen rapidly and not be workable.

A 'set-retarding' admixture may be added to the concrete during mixing to extend the working time.

See CHAPTER 2 Concrete Properties

In hot and/or windy weather, if concrete stiffens quickly, a cold unbonded joint may form between concrete already in place and the new concrete.

If there is a chance of this happening you may need to make a construction joint.

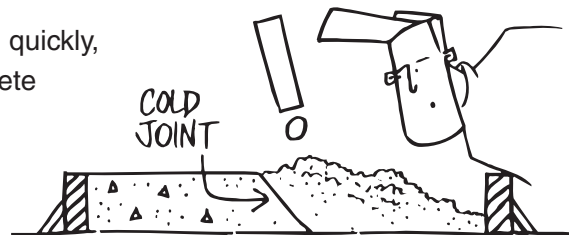

See CHAPTER 11 Joints

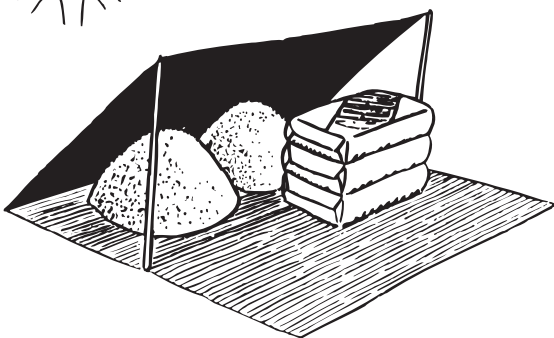

To reduce the risk of concrete drying out and cracking use one or more of the following:

Use SHADE to keep all materials out of direct sun and keep the aggregates MOIST.

DAMPEN subgrade and formwork, but don't leave excess water lying around.

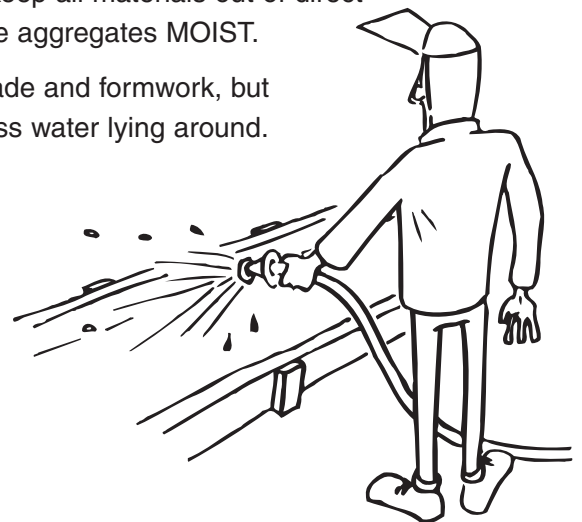

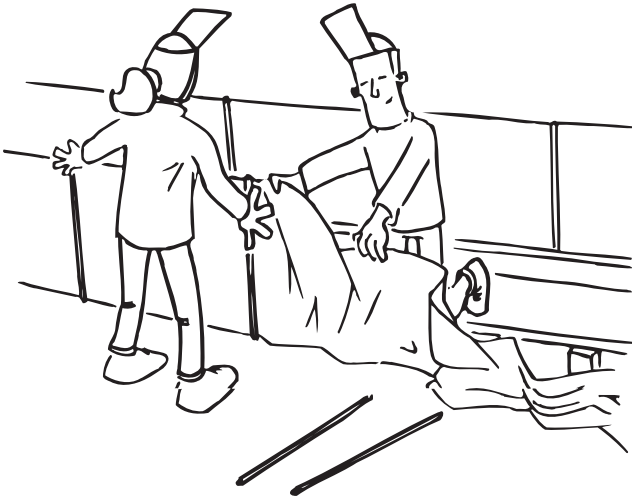

Erect **SHADES** and **WINDBREAKS** or try to place in the cooler parts of the day.

Avoid **DELAYS** once placing begins by planning ahead.

Use a 'set-retarding' **ADMIXTURE**.

SPRAY concrete with 'aliphatic alcohol' after the initial finishing, which reduces **EVAPORATION** and **CRACKING**.

CURE concrete carefully.

See CHAPTER 10 Curing

Keep it **COOL**. In extreme conditions iced water, or other methods, may be used in the mix to keep it cool. Do not apply cold water to a hot concrete surface as thermal cracking may result due to the sudden cooling.

IN COLD WEATHER Frozen or very cold water will also slow down the setting time which can cause costly delays. Concrete should not be allowed to freeze in the first 24 hours.

To stop concrete freezing use one or more of the following:

Keep all **MATERIALS** warm.

Use **WARM WATER** in the mix.

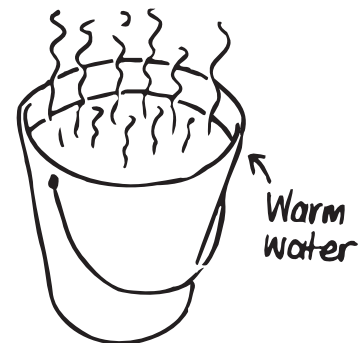
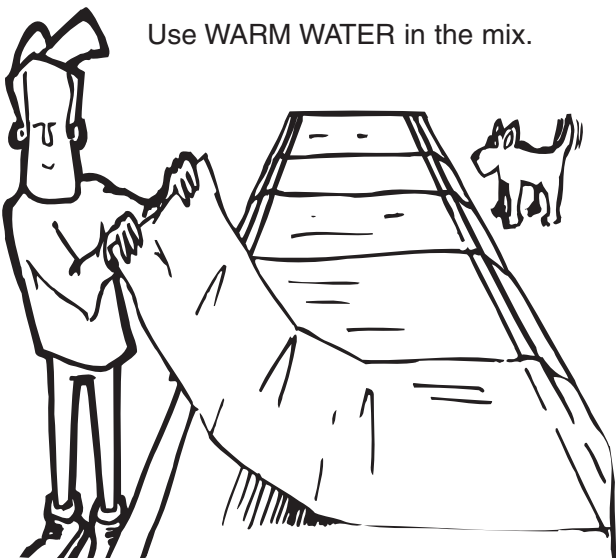

COVER the formwork and subgrade, to keep them free of frost and ice.

Use a 'Set-Accelerating' **ADMIXTURE**.

Try to keep concrete as much above 10°C as possible for the first few days.

NEVER lay concrete on frozen ground.

CURE concrete carefully to keep it warm. The best method will be one that **KEEPS HEAT** in the concrete. The curing methods should not cool the concrete. An insulating layer may be needed.

In cold climates with frequent freeze/thaw conditions the concrete may need an **Air-Entraining Admixture** for long-term durability.

In extremely cold weather water turns to ice, **EXPANDS** and can **CRACK** hardened concrete.

CHAPTER 13 Colouring and Surface Finishes

Concrete can be given many different surface finishes including:

STAMPING
BROOMING
EXPOSED AGGREGATE
POLISHING

COLOURING CONCRETE A coloured and/or textured/patterned surface finish can make concrete look more attractive and interesting. Colouring of concrete can be achieved by a variety of methods, and can be combined with texturing or patterning of the exposed surface. A wide range of colours, textures and patterns is available.

The constituents of the concrete itself will also influence its appearance, eg 'white' or 'off-white' cement can be used instead of the standard 'grey', while aggregates (where they are to be exposed at the concrete surface) can be selected for their colour.

To find out how a colour or pattern will look always do a small test area before beginning the bulk of the work.

CONCRETE GRADE In order to minimise problems arising when using any form of coloured concrete for domestic paving, a minimum grade of 25 MPa concrete should be used. Other forms of decorative concrete, or in commercial work, will normally require a higher grade of concrete.

CURING Adequate curing is a very important step in colouring concrete. The concrete surface must stay evenly moist or the colour will be uneven. Poorly cured concrete can even affect a painted concrete surface.

[See CHAPTER 10 Curing](#)

COLOURING METHODS There are several ways to colour concrete.

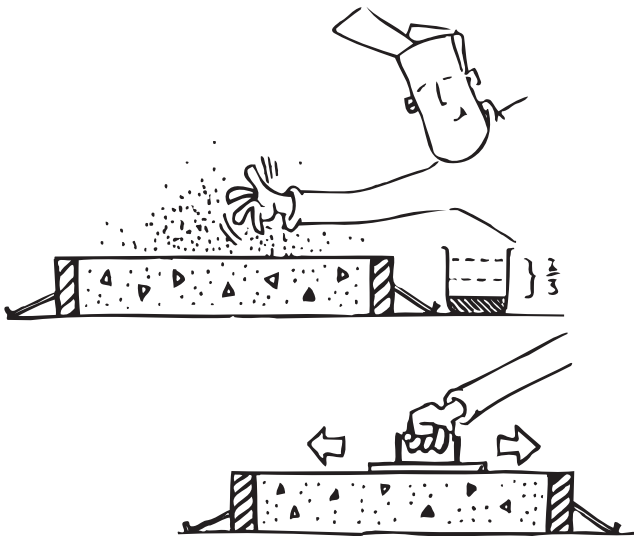

The Dry-Shake Method The dry-shake method uses a mixture of a mineral oxide pigment (or colour), cement and specially graded fine aggregates. The colour is added when compaction, screeding and bleeding has finished, as part of finishing. Uniform reliable results are best achieved if premixed concrete is used.

Shake $\frac{2}{3}$ of the dry colouring material onto the concrete surface, spreading it evenly with a float. Leave for a minute or so to soak up some moisture.

Shake the other 1/3 of the dry colouring material onto the concrete at right angles to the first application (if possible) and again, after it has dampened up, spread evenly with a float. The two applications help to give a more uniform colour and thickness.

Re-tool any edges and joints.

[See CHAPTER 11 Joints](#)

After a while the surface must be re-floated.

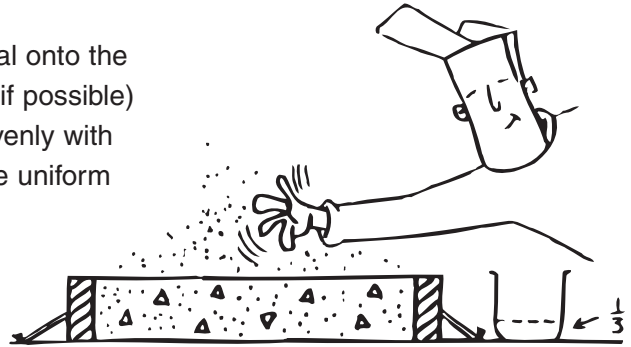

Full Depth Colour The colour is added to the concrete during mixing so all the concrete is coloured, then the concrete is compacted and finished as for normal concrete.

To achieve the required colour, the pigment additives should generally be in the range of 3–7% by weight of the cement. Higher quantities may affect the strength and durability of the concrete. Check manufacturer details for colour selection.

[See CHAPTER 2 Concrete Properties](#)

Each batch must be accurately proportioned, thoroughly mixed and well floated to give an even colour.

[See CHAPTER 9 Finishing](#)

The colour of the cement powder may effect the shade of the final colour, ie a dark grey cement may affect light colours.



Coatings Coatings, including paints, tinted sealers and trowelled-on coatings, provide a wide range of colours and are easily applied to hardened dry concrete.

Paint finishes are either water-based or solvent based. They will give an even colour but will wear easily and will need to be reapplied periodically.

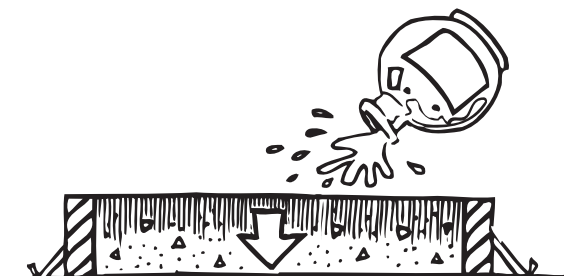

Chemical Stains A chemical stain soaks into the concrete surface and colours it by reacting with the cement paste in the surface layer, wearing away only as much as the surface does.

There is only a limited colour range in concrete stains.

PATTERNED FINISHES

Stamped A number of DIFFERENT PATTERNS can be stamped into the surface of setting concrete. This includes cobblestone, slate, tile, brick tile and timber finishes.

The concrete is placed and compacted normally, and floated once. A dry shake colour may also be used.

The pattern moulds or pads/mats are then placed carefully on the concrete surface. When mats are used a release agent will be needed to allow the mat to be removed. At least two moulds are needed to step from one to another giving continuous and matching pattern. Step onto the moulds, pressing them into the concrete surface to the desired depth; up to 6–10 mm for cobblestones and less for other patterns. Deep patterns may be a hazard for pedestrians.

When using pads, the grooves may be rounded by laying a sheet of plastic across the concrete surface before stamping. The surface may then be broomed to give a non-slip finish. Use small handstamps for the edges and any difficult to reach areas.

Stencilled Brick, tile or stone appearances can be obtained by floating a paper template into the concrete surface before applying a dry shake. The template forms the 'joint' lines in the pattern.

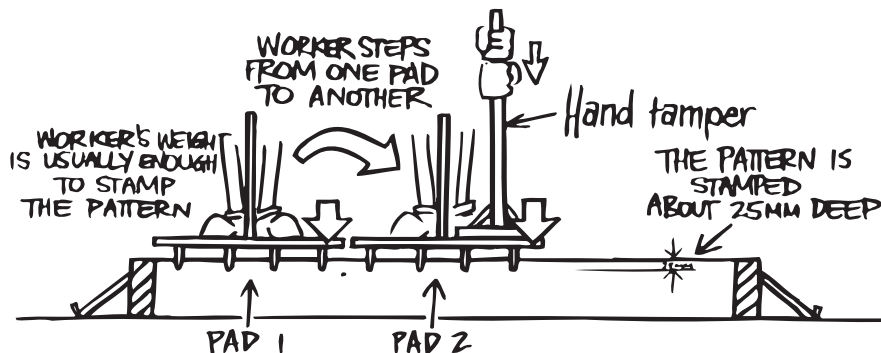

TEXTURED FINISHES

Broomed To give a skid-resistant surface a broom can simply be drawn across the surface of concrete. The broom can be drawn in straight or 's' shape lines. The depth of the texturing will depend on the stiffness of the broom's bristles and the pressure applied.

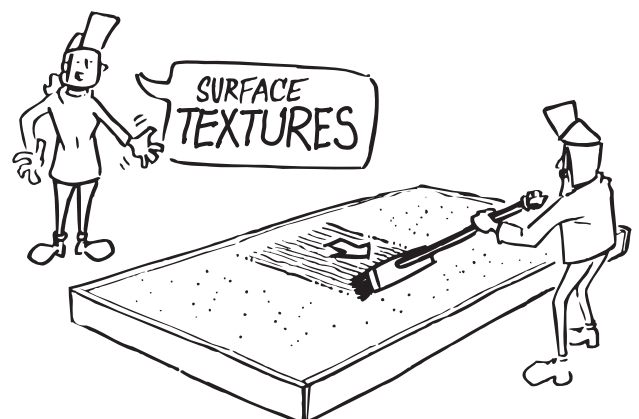

Exposed Aggregate Exposing the aggregate gives an attractive decorative finish. Different sizes and colours of aggregates allow many different appearances.

The concrete can be made as normal, and the coarse aggregate exposed. This is done by waiting until the surface is firm, but not dry, then brushing, washing or brooming away any cement paste until the aggregates are exposed. The concrete is then cured.

A surface retardant can be used to aid the process.

Alternatively, there are two ways to get an exposed aggregate finish by adding special aggregates to the surface immediately after the concrete has been placed.

METHOD 1

Place, compact and level the concrete to about 10 mm below the top of the forms.

Spread selected aggregates over the concrete in a layer and press them into the concrete until completely covered.

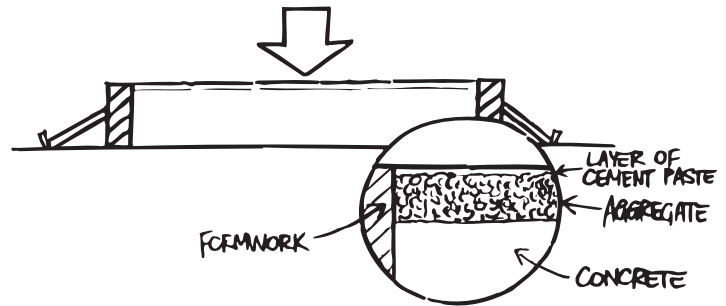

METHOD 2

Place, compact and level the concrete to about 5 mm below the top of the forms.

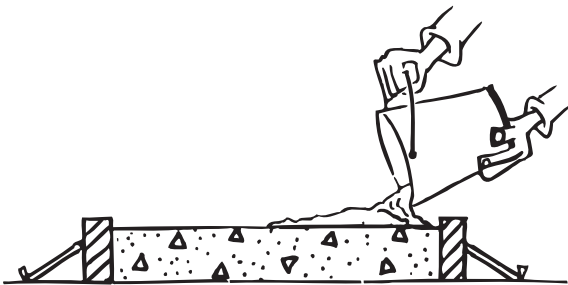

Mix a 'Topping Coat' – a mix of aggregates and cement paste in the ratio 2:1. Use only enough water to make the mix workable.

[See CHAPTER 2 Concrete Properties](#)

Spread the topping over the concrete, level, tamp down and finish with a trowel.

FOR BOTH METHODS leave the concrete until the cement paste on the surface is firm, but not dry, then brush or, with a fine mist spray, wash away some of the cement paste covering the aggregates.

In both cases extra cleaning can be done with a dilute solution of hydrochloric acid. The solution should be 1 part acid to 20 parts water (adding the acid to the water). Wet the concrete first and rinse off thoroughly afterwards. Observe safety procedures.

[See CHAPTER 15 Removing Stains](#)

To see what an aggregate finish will look like, do a test area first. Different colours of cement can be used to get a better effect. For instance a white or off-white cement may be used with a light stone where a grey cement may create a clash of colours.

Polished Polished concrete is a finish used on the interior and exterior of dwellings. A variety of finishes can be achieved by using different techniques or products. The different finishes can be achieved by using liquid polishes, latex coatings, chemical sealers, grinding to expose the aggregates, colouring, staining and using special aggregates to achieve other desired effects.

For further details refer to [Polished Concrete Floors – Briefing 05](#)

CHAPTER 14 Defects

Some defects are obvious only to a trained eye, others, such as cracking, are obvious to anyone. Some common defects, their causes and how to prevent and repair them are explained below. If in doubt, consult an expert.

COLOUR VARIATION

Variations in colour across the surface of concrete. May appear as patches of light and dark.

Causes

Uneven or variable compaction and curing conditions.

See CHAPTER 8 Compacting and CHAPTER 10 Curing

Addition of excess water.

Segregation of materials (in coloured concrete).

Variable colour dosage.

Prevention Use uniform concrete mix and use consistent placing, compacting, finishing and curing procedures. Do not use driers.

Repair Many colour variations from workmanship will be permanent. To hide the variation a SURFACE COATING can be applied.

Rectification of colour variation from stains is a very difficult operation and may need repeated gentle treatments with a weak acid.

See CHAPTER 15 Removing Stains

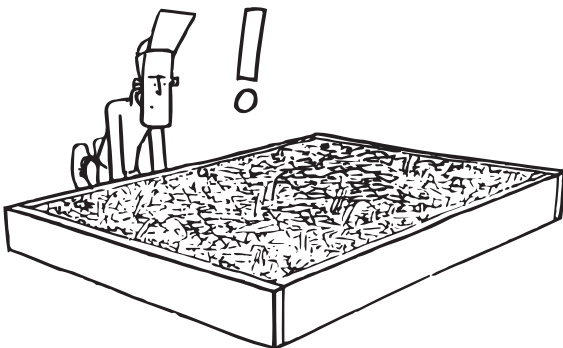
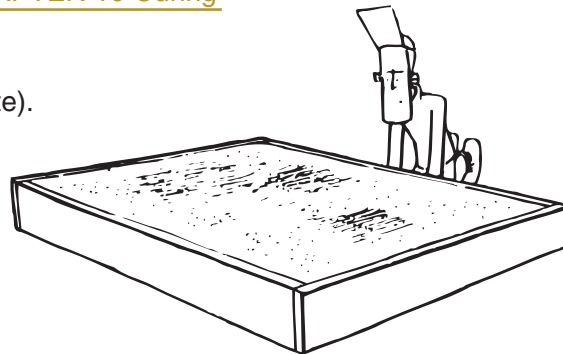
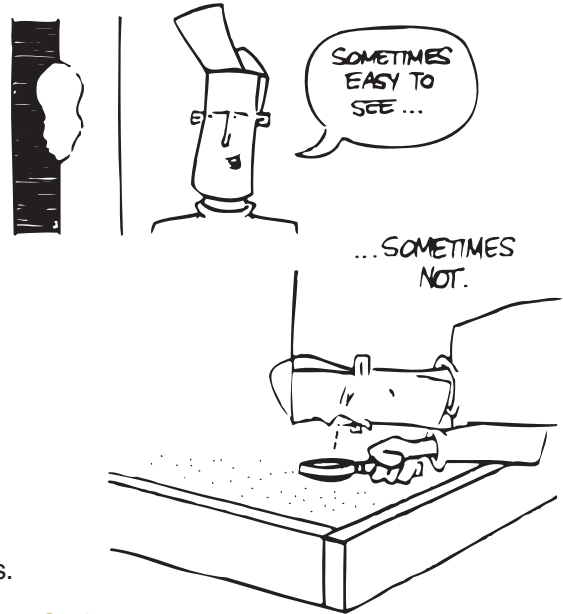

CRAZING

A network of fine cracks across the surface of concrete.

Causes Cracking is caused by minor surface shrinkage in rapid drying conditions (ie low humidity and high temperatures, or alternate wetting and drying).

Prevention Use an evaporative retarder and initiate curing immediately after finishing the concrete.

See CHAPTER 9 Finishing and CHAPTER 10 Curing

Repair Repair may not be necessary because crazing will not weaken concrete. If the appearance is unacceptable, a surface coating of a paint or other overlay sealer can be applied to hide the cracks.

[See CHAPTER 13 Colouring and Surface Finishes](#)

DUSTING

A fine powder on the concrete surface which comes off on your fingers.

Causes

Finishing before the bleed water has dried.

Finishing during the rain.

[See CHAPTER 9 Finishing](#)

Not curing properly, or the surface is drying too quickly.

[See CHAPTER 10 Curing](#)

Concrete of too low a grade for the end use (eg subject to severe abrasion).

Prevention

Let any bleed water dry up before trowelling or, in cold conditions, remove the water.

Cure correctly.

[See CHAPTER 10 Curing](#)

Protect concrete from drying out too quickly in hot or windy conditions.

For harsh conditions use a stronger concrete.

Do not add excess water before placing.

Repair Where surface dusting is minimal, the application of a surface hardener can be beneficial. If the surface is showing significant wear, it is essential to remove all loose material by grinding or scraping the surface to a sound base and then applying a suitable topping, if required.

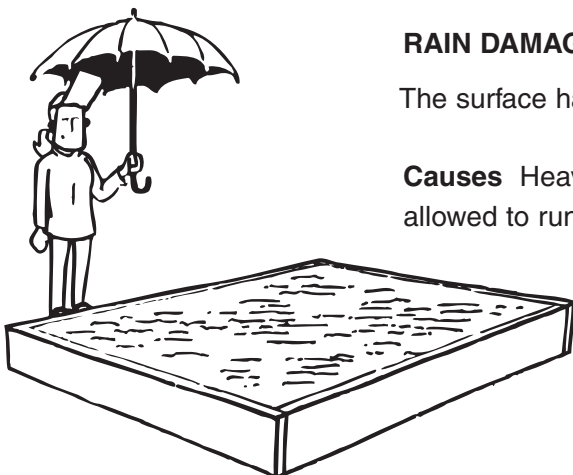
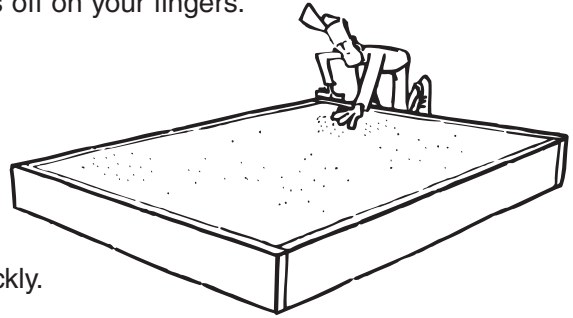

RAIN DAMAGE

The surface has bits washed away or many small dents.

Causes Heavy rain while concrete is setting or rainwater being allowed to run across the concrete surface.

Prevention Don't place concrete if rain looks likely. If concrete has already been placed and rain looks likely, cover it and prevent water from running across it.

Repair If the concrete has not hardened and damage is minimal the surface can be refloated and re-trowelled taking care not to work excess water into the surface.

See CHAPTER 9 Finishing

If the concrete has hardened it may be possible to grind or scrape off the damaged surface layer and, if required, apply a topping layer of new concrete or a repair compound. This may not always be possible and should be done only on expert advice.

SPALLING

When the slab edges and joints chip or break leaving an elongated cavity.

Causes

Edges of joints break because of heavy loads or impact with hard objects. As concrete expands and contracts the weak edges may crack and break.

Entry of hard objects, such as stones, into joints may cause spalling when the concrete expands.

Poor compaction of concrete at joints.

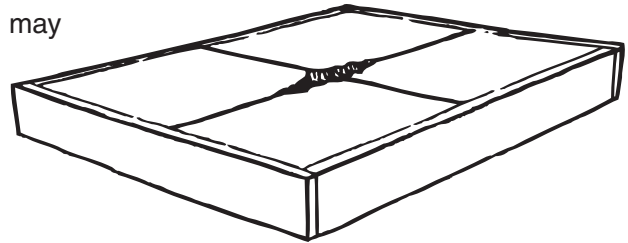

Prevention

Design the joints carefully.

Keep heavy loads away from the joints and edges until the concrete has hardened.

Ensure proper compaction.

Keep joints free from rubbish.

Repair

For small spalled areas: scrape, chip or grind away the weak areas until you reach sound concrete, making sure you brush any loose material off the slab. Then refill the area with new concrete or repair mortar (after applying a bonding agent to the old concrete if necessary). Compact, finish and cure the new patch carefully. Care should be taken that all joints are maintained and not filled.

For large spalled areas: seek expert advice

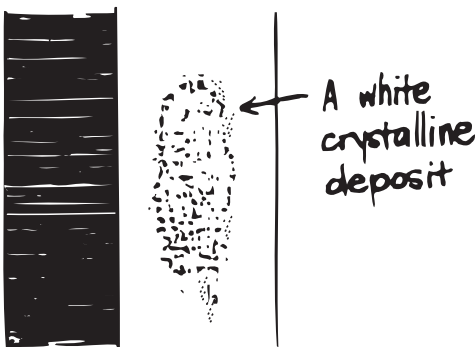

EFFLORESCENCE

A white crystalline deposit sometimes found on the surface of concrete.

Causes

Water with dissolved mineral salts collect on the concrete surface, as water evaporates salt deposits are left on the surface.

Excess bleeding may also result in efflorescence.

Prevention Use clean, salt-free water and washed sands. Avoid excessive bleeding.

Repair Remove efflorescence by dry brushing and washing with clean water. Do not use a wire brush. If this fails to remove the deposit, wash with a dilute solution of hydrochloric acid.

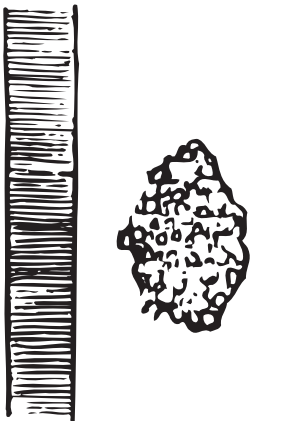

HONEYCOMBING

Coarse, stony surface with air voids.

Causes Poor compaction, segregation during placing or paste leakage from forms. A poor concrete mix with not enough fine aggregate causing a stony mix. Workability too low.

Prevention Use a better mix design. Take care during placing concrete to avoid segregation. Compact concrete properly. Good watertight formwork.

Repair If honeycombing occurs only in a thin surface layer it can be rendered (ie applying a layer of mortar). If honeycombing occurs to a greater depth, the concrete may need to be removed and replaced.

BLISTERING

Blisters are hollow, low-profile bumps on the concrete surface filled with either air or bleed water.

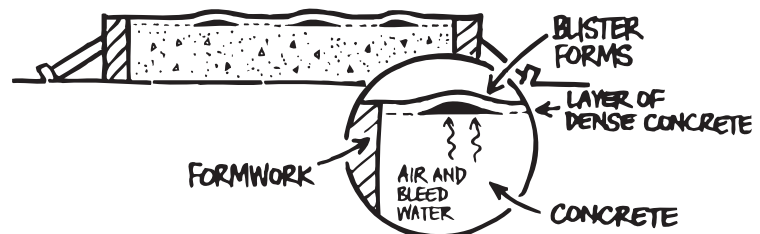

Causes They are caused when the fresh concrete surface is sealed by premature trowelling, trapping air or bleed water under the surface layer. This is more likely to occur in thick slabs or on hot, windy days when the surface is prone to drying out.

Prevention After placing, screeding and floating leave the concrete as long as possible before trowelling.

If blisters are forming, delay trowelling as long as possible and take steps to reduce evaporation by using an evaporative retarder.

Repair Grind off the weakened layer to an even finish, or remove blisters and apply a repair mortar or epoxy coating.

CHAPTER 15 Removing Stains

Simple stains and everyday grime can be removed by washing and scrubbing. Water jet washing may also be successful. Stains from oil, rust or paint leave ugly marks on concrete, ruining its appearance. These stains penetrate the concrete surface and can often be very difficult to remove.

A stain may be removed using a special chemical stain remover, or a specially prepared chemical mix. In extreme cases if a stain cannot be removed chemically, it may be sand blasted. This removes the surface of the concrete and may expose the aggregates.

Some types of stains can be covered by simply painting over with a concrete paint. However, oil-based stains may prevent adhesion of the paint and must be removed first.

Stain-removal procedures are outlined below; comprehensive guidance is provided in CCAA's online Data Sheet [Removing Stains from Concrete](#).

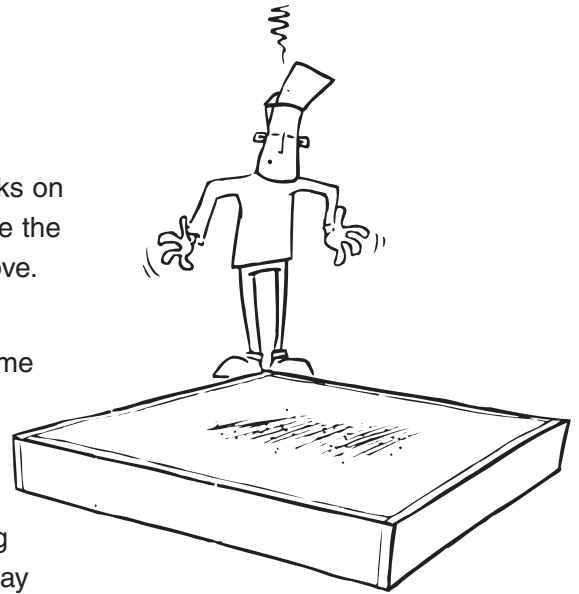

RUST

Staining resulting from metal objects placed on the concrete can usually be removed by using a special cleaning chemical available from most hardware stores. For stubborn stains, a weak solution (1:25) of hydrochloric acid may be successful. Prior to applying the acid solution, wet the concrete and always wash down the surface with clean water afterwards. Be careful where the run off goes as it may create problems on other concrete surfaces or gardens. A poultice method may also be used.

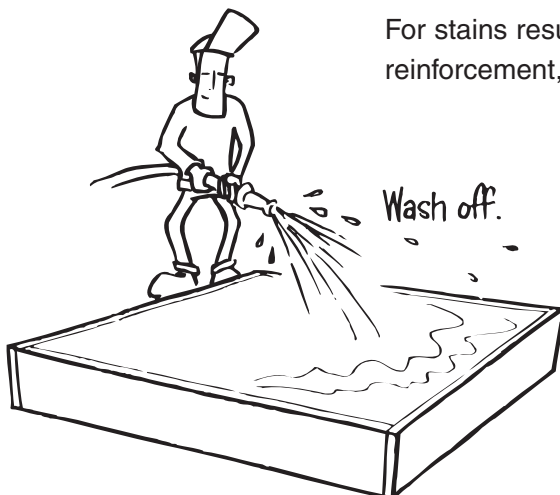

For stains resulting from rusting of the embedded steel reinforcement, seek professional advice.

PAINT

New spillages should be soaked up immediately to prevent spreading.

If the paint is water-based, scrub the area with an abrasive cleaning powder and rinse with water.

If the paint is oil-based, allow it to dry and then scrape off as much paint as possible and apply a paint stripper. After 20–30 minutes scrub gently to loosen the paint film and rinse with water.

OIL AND GREASE

These can be difficult to remove completely because they tend to soak into the concrete surface. If the oil or grease has hardened it can simply be scraped off. If an oil or grease spill has just occurred, stop it spreading by encircling it with sand, dirt, sawdust or cat litter. These can also be used (along with paper towels and cloths) to soak up or remove as much of the oil and grease as possible.

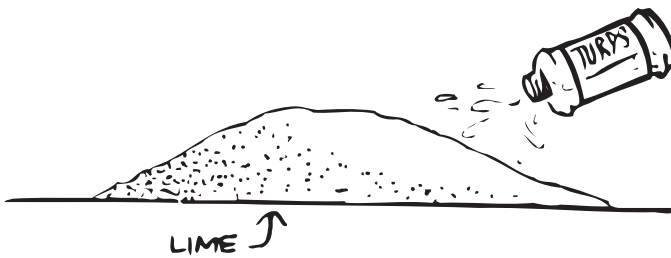

Cover residue stain with a poultice of 1 part lime to 2 parts mineral turpentine. Spread a 5-mm layer of the paste over the stained area and 50–100 mm beyond it. Cover with plastic sheeting and leave for 24 hours.

Remove the cover and scrape off the powder. It may be necessary to repeat this process within a day or so to remove any deeply ingrained oil or grease. Scrub with warm water and laundry detergent, then rinse with clean water.

Cleaning products such as sugar soap may be adequate to remove light oil or grease stains.

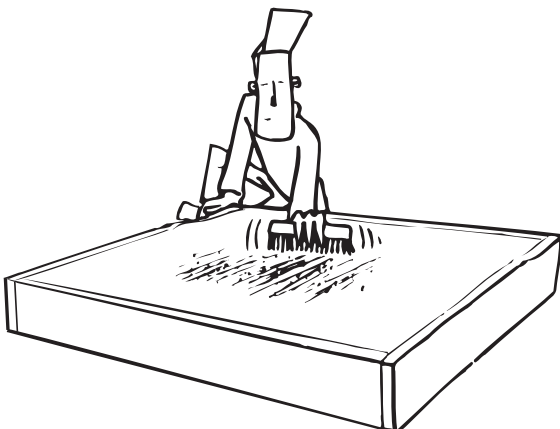
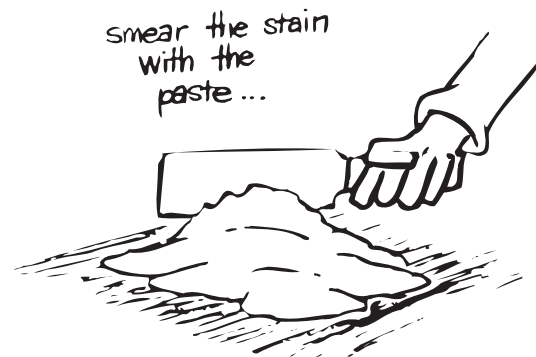
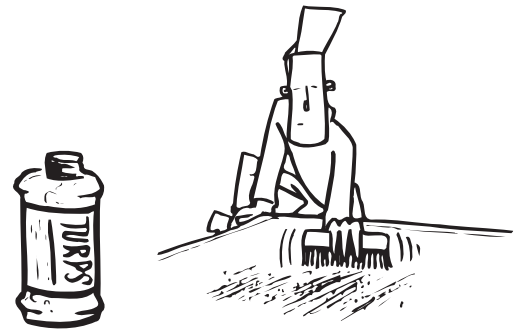

TIMBER

To remove timber stains, scrub vigorously with a domestic chlorine bleach then rinse the surface.

Stubborn stains may need to be repeatedly covered in a cloth soaked in bleach. Scrub between bleach treatments and rinse the surface.

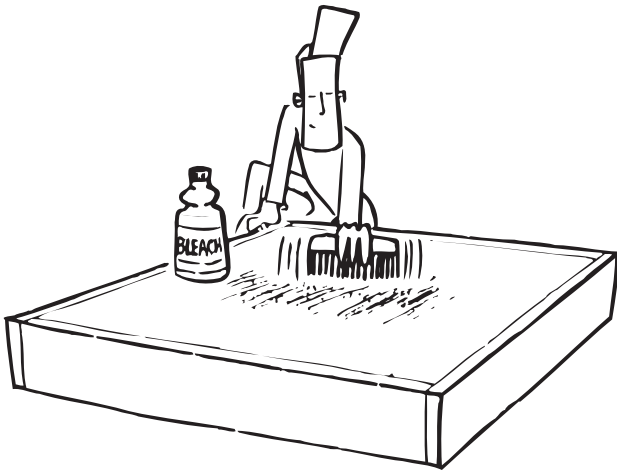

ALGAL AND FUNGAL GROWTH

Algal and fungal stains are removed with domestic chlorine bleach.

Wash and scrub the area with bleach.

Leave for a few days.

Scrub or scrape growth off.

Wash with water.

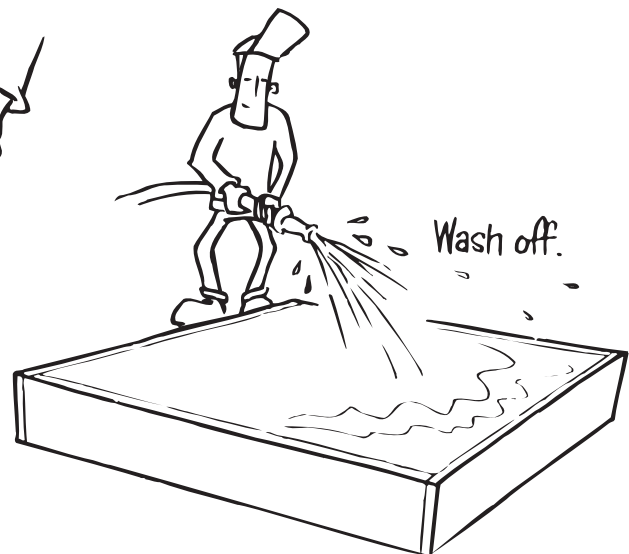
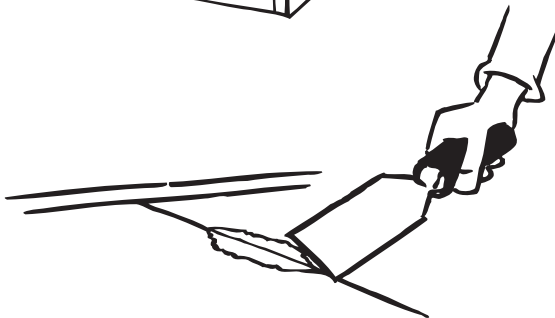

RUBBER OR TYRE MARKS

Try pressure washing. If this fails, use a rubber-removal compound available from hardware stores. Brake-cleaning products may also work.

Test products on a small area first and thoroughly rinse surface afterwards.

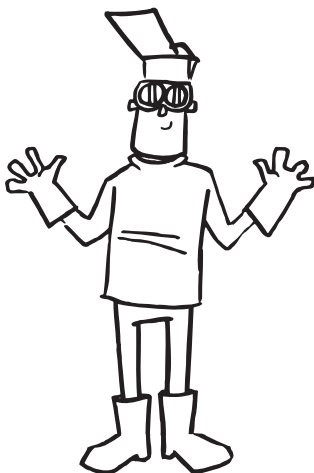

SAFETY

When using any chemicals (especially acids) mentioned in this chapter always wear protective clothing, gloves and shoes. Protective goggles and face masks may also be necessary.

Don't breathe in fumes from any of these chemicals.

If chemicals come in contact with skin or eyes, wash the area with plenty of cold water, and seek medical advice.

Always read the safety directions on the label of any chemical container prior to starting work.

CHAPTER 16 Cracking

Random cracking in concrete is not desirable, it can spoil the appearance and lead to structural weakness of the concrete.

Reinforcement and joints are used to control cracking. Bad cracking leaves the reinforcement exposed to air and moisture, which may cause it to rust and weaken concrete.

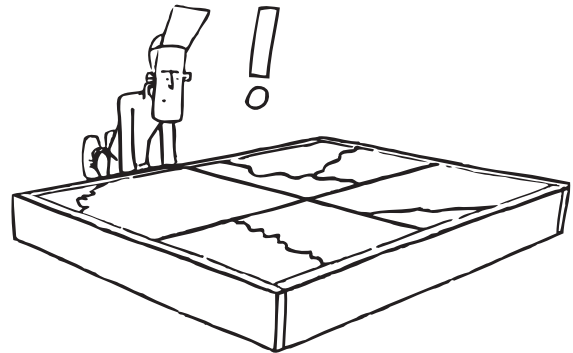

See CHAPTER 11 Joints and CHAPTER 17 Reinforced Concrete

TYPES OF CRACKS

Two types of cracks occur in concrete:

PRE-HARDENING CRACKS Cracks that happen BEFORE concrete hardens, while it is still workable.

HARDENED CONCRETE CRACKS Cracks which occur AFTER concrete hardens.

PRE-HARDENING CRACKS Pre-hardening cracks are cracks which form during placing, compaction and finishing caused by movement of concrete before it is dry.

There are three types of pre-hardening cracks:

PLASTIC SETTLEMENT cracks

PLASTIC SHRINKAGE cracks, and

Cracks caused by **MOVEMENT OF THE FORMWORK**.

Pre-hardening cracks, if they are detected early, can be easily rectified by re-compacting, re-trowelling or re-floating the concrete surface.

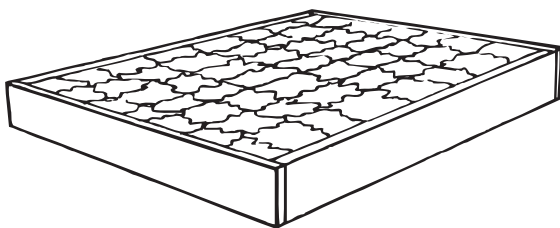
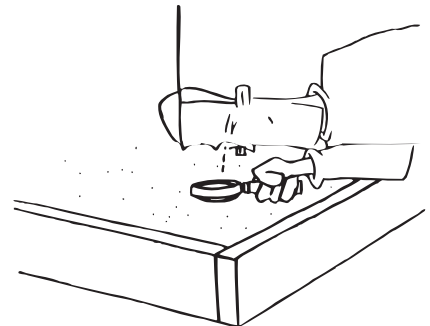

Plastic Settlement Cracks

When do they form? They form soon after concrete is placed, while it is still plastic. They get bigger as concrete dries and shrinks and tend to follow the lines of reinforcement.

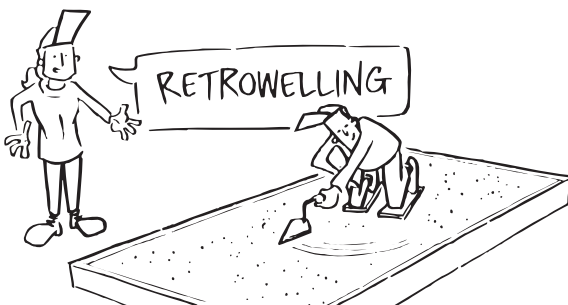

Correction

Revibrate the concrete.

Re-trowel the surface.

Look for cracks as the concrete is setting. At this stage they can easily be fixed.

Plastic Shrinkage Cracks

When do they form? On very hot days or in low humidity and even moderate winds. They are more common in summer but may occur in winter.

See CHAPTER 12 Hot and Cold Weather Concreting

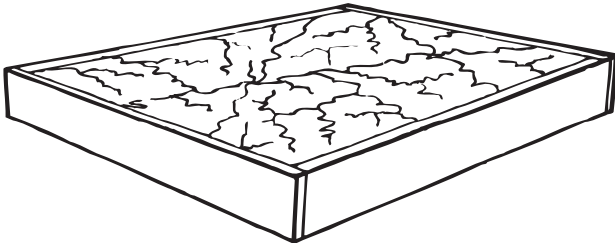

Plastic shrinkage cracks appear in lines, roughly parallel or in a crazed haphazard way. They are usually 300–600 mm long but may be between 25 mm and 2 m in length.

Prevention

Dampen the subgrade and forms and protect concrete from the wind.

Keep all materials cool on hot days. Place, compact and cure as quickly as possible on hot days so concrete won't dry out.

Once the concrete has been compacted, screeded and floated, apply a uniform spray film of EVAPORATIVE RETARDER (eg Aliphatic Alcohol) to prevent rapid loss of surface moisture, then continue with finishing.

Try to place at the cooler times of the day.

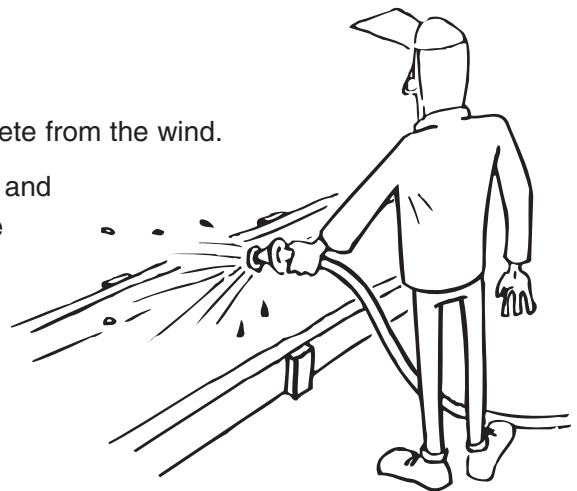

Repair Cracks may be closed by reworking the plastic concrete.

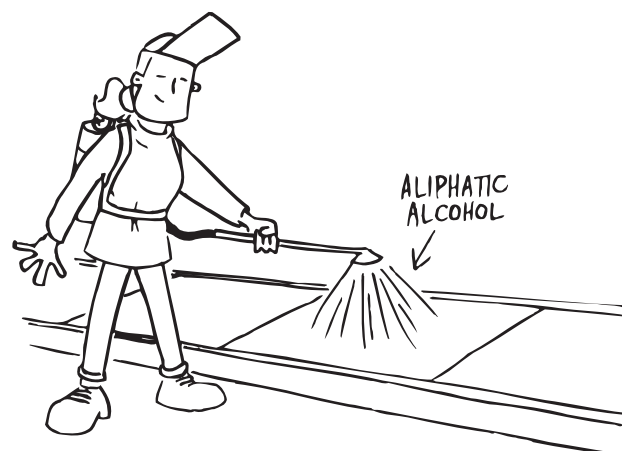
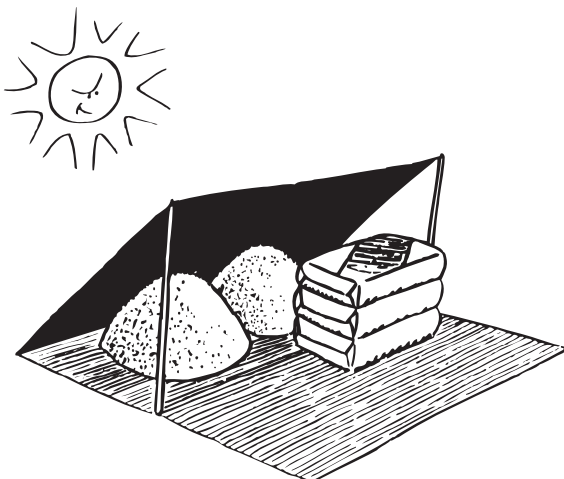

Formwork Movement

If formwork is not strong enough it may bend or bulge. Formwork movement may happen at any time during placement and compaction.

Prevention Make sure formwork is strong.

If the concrete collapses, strengthen the formwork and re-vibrate the concrete.

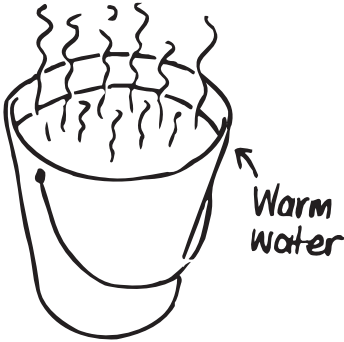

Thermal Shock

Applying cold water (for curing) over concrete on a hot day can result in cracks from the sudden contraction.

Prevention Use warm water or other curing method.

CRACKS IN HARDENED CONCRETE

Cracks after hardening may be caused by drying shrinkage, movement or settling of the ground, or placing higher loads on the concrete than it was designed to carry.

Little can be done with cracks after hardening. Careful and correct placement helps prevent serious cracking after hardening.

Only uncontrolled cracks are a possible problem. Cracking at control joints or controlled by steel reinforcing is expected and acceptable.

CHAPTER 17 Reinforced Concrete

The steel found in many concrete structures is called REINFORCEMENT.

Reinforcement helps concrete resist TENSILE and SHEAR forces, and helps control CRACKING in concrete.

CONCRETE PROPERTIES

Normal Concrete:

HIGH compressive strength

VERY LOW tensile strength

VERY LOW shear strength

Reinforced Concrete:

VERY HIGH compressive strength

VERY HIGH tensile strength

VERY HIGH shear strength

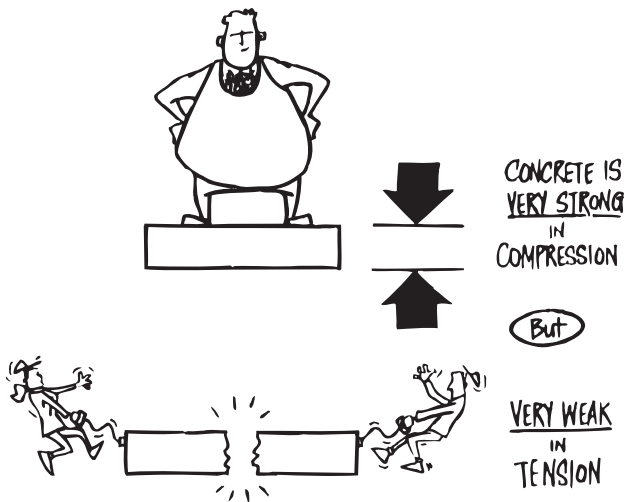

WHY USE REINFORCEMENT?

As a load is applied, compressive, tensile and shear forces will act on the concrete. Concrete naturally resists compression (squashing) very well, but is relatively weak in tension (stretching).

Horizontal and/or vertical reinforcement is used in all types of concrete structures where tensile or shear forces may crack or break the concrete. HORIZONTAL reinforcement helps resist tension forces. VERTICAL reinforcement helps resist shear forces.

Below are some examples of reinforcement use:

In a SUSPENDED (off-the-ground) concrete slab, horizontal reinforcement resists tension while vertical reinforcement (in say supporting beams) resists shear forces.

In a SLAB-ON-GROUND, reinforcement increases the tensile strength and helps control the width of shrinkage cracks.

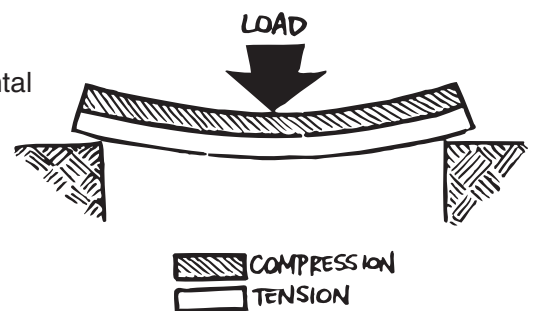

See CHAPTER 16 Cracking

Reinforcement does not prevent cracks but controls their width.

Another benefit is that it reduces the number of control joints required. It is particularly beneficial in odd-shaped slabs.

REINFORCEMENT POSITION

The position of reinforcement will be shown in the plans. Reinforcement must be fixed in the right position to best resist compressive, tensile and shear forces and help control cracking.

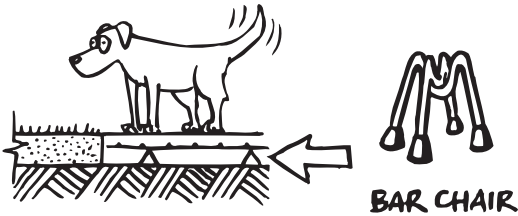

The reinforcement in trenches and slabs rests on BAR CHAIRS and must be securely fixed to the bar chairs so it won't move when concrete is placed around it.

Concrete Cover The reinforcement must be placed so there is enough concrete covering it to protect it from rusting.

Typical covers are shown in the diagram below. Both the concrete cover and strength should be shown in the plans.

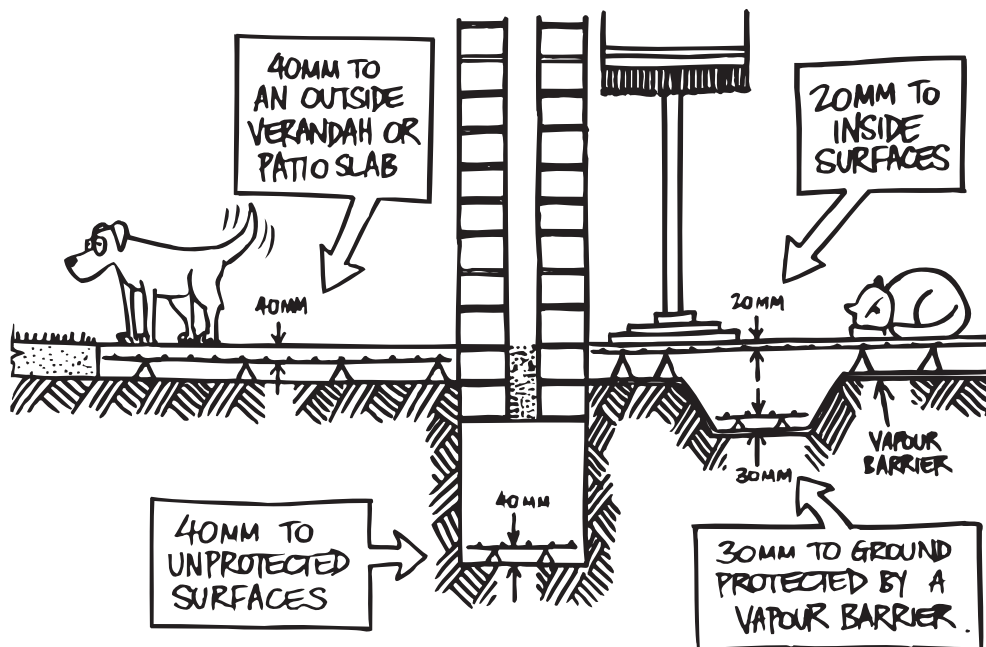

Concrete Reinforcement Bond To help control the width of cracks, or their location (at joints), there must be a strong bond between concrete and reinforcement. This allows the tensile forces (which concrete has a very low ability to resist) to be transferred to the reinforcement.

To help achieve a strong bond:

The reinforcement should be **CLEAN** (free from flakey rust, dirt or grease).

The concrete should be **PROPERLY COMPACTED** around the reinforcement.

Reinforcing bars and mesh should be located so that there is enough room between the bars to place and compact the concrete.

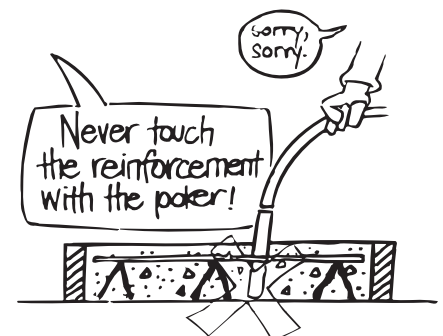

To improve the transfer of tensile forces to the steel, the reinforcement is often anchored by:

BENDING,
HOOKING, or
LAPPING the bars.

Types of Reinforcement Two types of steel reinforcement used are mesh sheets or individual bars.

Bars are normally deformed, while mesh may be made from either smooth or deformed bars. Typical bar diameters are 12, 16, 20 and 24 mm.

Typical mesh sizes are SL42, 52, 62, 72 and 82. The SL stands for Square mesh Low Ductility and the numbers also have meanings. For example, for SL42 the 4 is the nominal wire size (mm) and the 2 refers to the wire spacing (200 mm).



Deformed bar

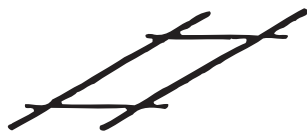

RECTANGULAR MESH

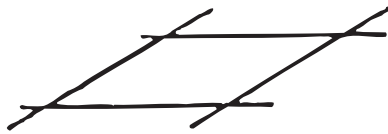

SQUARE MESH

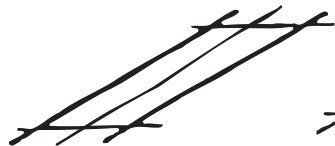

TRENCH MESH

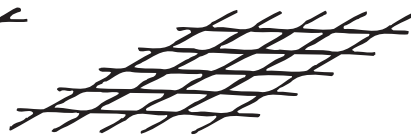

GIRDER WRAP

Fibre Reinforcement Synthetic fibres can be added to concrete to help minimise early-age plastic shrinkage and can reduce the presence of excessive bleedwater. However, synthetic fibres are not a replacement for mesh or bar reinforcement. In slab-on-ground construction the control joint spacing is the same as for plain concrete.

Steel fibres are used for the above and to improve the toughness of concrete. They can also be used to control drying shrinkage cracking over limited spacings and for odd-shaped slabs. They also increase the flexural, or bending, strength of concrete.

CHAPTER 18 Formwork

Formwork gives concrete its SHAPE.

Formwork provides a mould, into which concrete is placed. When concrete has hardened the formwork is removed.

Formwork must be:

ACCURATE
STRONG, and
WELL MADE.

This is necessary so that the concrete will not leak from the joints, and so that the formwork will not sag, bulge or move and, especially in large construction, will be safe.

The surface of the forms in contact with concrete affects how concrete will look. If the final appearance of the concrete is important, choose a material that will give the required surface texture.

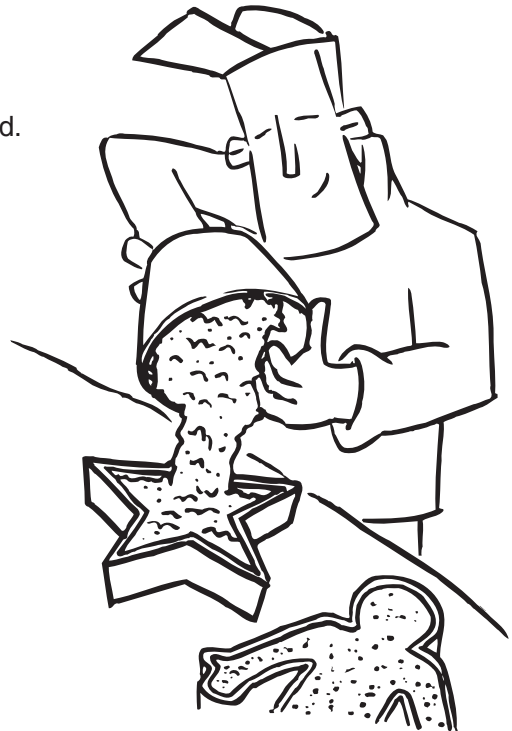

PLACEMENT

Be sure that formwork is placed so it can be removed. If formwork is placed in awkward positions or tight corners it may be difficult to remove when the concrete has hardened.

It is helpful if formwork is:

SIMPLE to build,
EASY to handle, and
RE-USEABLE.

Formwork sections should be of simple design, not too big and of standard sizes if they are to be re-used.

MATERIALS

Formwork is normally made from steel or timber. Timber formwork is easier to make while steel formwork will allow a greater number of re-uses.

Formwork can be made on site or bought from formwork suppliers. Special forms made from various materials can be purchased for forming waffle slabs, circular columns and other special profiles.

FORM RELEASE AGENT

Form Oil should be applied to the inside of the formwork to stop it sticking to the concrete and thus make removal easier. Coat **BEFORE** the reinforcement is put in place.

REMOVAL TIMES

Formwork may be left in place to help curing.

See CHAPTER 10 Curing

Removal time will vary according to the weather,

In cold weather, concrete will take longer to gain strength than in warm weather, removal times will therefore be longer.

In mild conditions (around 20°C) 7 days is long enough to leave the forms in place, unless the concrete is suspended when other considerations apply.

